

SC300 System Controller Operation Handbook

Issue: IPN 997-00012-03 1.4.1

Issue Date: 19 July 2021

Eaton Corporation
Telecommunications Power Solutions
dcpower.eaton.com
DCinfo@eaton.com

The product discussed in this literature is subject to terms and conditions outlined in Eaton selling policies. The sole source governing the rights and remedies of any purchaser of this equipment is the relevant Eaton selling policy.

No warranties, express or implied, including warranties of fitness for a particular purpose or merchantability, or warranties arising from course of dealing or usage of trade, are made regarding the information, recommendations and descriptions contained herein.

In no event will Eaton be responsible to the purchaser or user in contract, in tort (including negligence), strict liability or otherwise for any special, indirect, incidental or consequential damage or loss whatsoever, including but not limited to damage or loss of use of equipment, plant or power system, cost of capital, loss of power, additional expenses in the use of existing power facilities, or claims against the purchaser or user by its customers resulting from the use of the information, recommendations and descriptions contained herein.

The information contained in this literature is subject to change without notice.

Subject to the right to use its equipment, Eaton Corporation does not convey any right, title or interest in its intellectual property, including, without limitation, its patents, copyrights and know-how.

No part of this literature may be reproduced or transmitted in any form, by any means or for any purpose other than the Purchaser's personal use, without the express written permission of Eaton Corporation.

Eaton®, Matrix, Powerware®, Intergy™, CellSure™, SiteSure™, PowerManagerII™ and DCTools™ are trade names, trademarks, and/or service marks of Eaton Corporation or its subsidiaries and affiliates. Unless otherwise noted, brands, product names, trademarks or registered trademarks are the property of their respective holders.

Copyright © 2007-2018 Eaton Corporation. All Rights Reserved.

Scope

This guide covers operation of the SC300 system controller.

☐ See SC300 Identity Information on page 15 to determine the version of the embedded software.

Audience

This guide is intended for use by:

- Installers competent in:
 - installing and commissioning dc power systems
 - safe working practices for ac and dc powered equipment
 - the relevant local electrical safety regulations and wiring standards
- Operators and maintenance staff competent in:
 - operation of dc power systems
 - safe working practices for ac and dc powered equipment

Related Information

- *PowerManagerII* Online Help
- SiteSure-3G Installation and Operation Guide – IPN 997-00012-51
- SC300 Secure Configuration Guidance Available on request from Eaton.

Reporting Problems with this Guide

Please use this email address to report any problems you find in this guide:

DCInfo@eaton.com

For Further Information and Technical Assistance

For further information and technical assistance see Worldwide Support on page 159.

Third Party Software

This product includes cryptographic software written by Eric Young (eay@cryptsoft.com).

This product includes software developed by the OpenSSL Project for use in the OpenSSL Toolkit (<http://www.openssl.org/>).

End User License (EULA)

Use of the SC300 and associated software is subject to the EULA. Refer to page 142 for the full text.

About This Guide	i
Scope	i
Audience.....	i
Related Information	i
Reporting Problems with this Guide	i
For Further Information and Technical Assistance	i
Third Party Software.....	i
End User License (EULA)	i
Table of Contents	i
General Description	1
Overview	1
SC300 System Controller	1
Input/Output Board	2
Connections.....	4
Compatible Software	4
SC300 Operation	7
Overview	7
Starting the SC300	7
Main Screen Shortcut Keys.....	8
SC300 Operation using the Keypad and Screen.....	8
Soft Keys	8
Navigation Keys	9
Main Menu Navigation.....	9
Sub-menu Tabs	10
Changing a Configuration Setting using the Keypad.....	11
Keypad Access Security	12
Display Settings	12
Main Screen Parameters	13
Display Time-out.....	13
Alarm Indicators.....	13
SC300 Operation Using a PC/Laptop	14
SC300 Identity Information.....	15
Generic System Types.....	17
SC300 Internal Clock.....	18
Time Zones	20
Language Options	24
Language selection	24
SC300 Firmware Upgrade	24
Configuration File	25
Backup and Restore.....	25
System Operation	27
Overview	27
Voltage Control.....	27
Float Voltage	28
Active Voltage Control (AVC)	29
Battery Current Limit (BCL).....	29
Battery Test.....	31
Equalize.....	32
Fast Charge.....	33
Temperature Compensation.....	35
Peak Load Reduction (PLR)	36
Solar Charger Power Share.....	38
Rectifiers	39
Phase Detection.....	41
Identify a Rectifier	42
Rectifier Comms Lost Alarm.....	42
Solar Comms Lost Alarm.....	42

Rectifier / Solar charger Shutdown.....	42
Load Based Rectifier Shutdown.....	44
Low Voltage Disconnect (LVD).....	45
Typical LVD Arrangements.....	46
LVD Operation.....	48
LVD Setup.....	49
Smart Alarm Disconnect.....	51
Alarms.....	52
Types of Alarms.....	52
Active Alarm Indications.....	52
Alarm Change Indication.....	53
Common Alarm Parameters.....	54
System Alarm Configuration.....	54
System Alarm Reset.....	55
System Overload Alarms.....	56
Smart Alarms.....	57
Batteries.....	65
Batteries Configuration.....	66
Battery Symmetry Monitoring.....	67
Battery Time Remaining.....	70
Reset Ah Discharged.....	73
Reverse Battery Detection.....	74
Generator Control.....	75
Configuration.....	77
Fuel Management.....	78
Input/Output (I/O).....	79
Identify an I/O Board.....	79
Analog System Values.....	81
Analog Inputs.....	83
Smart Analogs.....	84
System States.....	86
Digital Inputs.....	86
Digital Outputs.....	88
Alternative Energy Input Metering.....	89
Energy Metering.....	89
Fan Controller.....	92
Data Logging.....	94
Standby Mode.....	97
Configuration.....	97
DC/DC control.....	99
A/B systems.....	99
Communications.....	101
Overview.....	101
Communications Options.....	101
Direct (USB) Communications.....	101
Ethernet Communications.....	101
PowerManagerII Communications Setup (if required).....	104
Communication via Web Browser.....	104
Communication via a Network Management System using SNMP.....	106
To communicate using SNMP V3.....	106
To send alarms as SNMP traps.....	107
To change SNMP trap sending options by trap source.....	108
Communication via email.....	108
Modbus-TCP Communications.....	109
Serial (RS-232) Communications.....	111
GSM Modem Communications.....	111
Serial Server.....	113
Communications Security.....	114
Serial Communications (USB / RS-232) Security.....	114
Web Access Security.....	115

Maintenance	117
Overview	117
Troubleshooting.....	117
Replacing the System Controller or I/O Board.....	122
Specifications	123
SC300 system controller	123
IOBGP I/O Board.....	123
Alarm Descriptions.....	127
Connector Pin-outs	131
System Controller Connector Pin-outs.....	131
I/O Board (IOBGP-xx) Connector Pin-outs.....	132
System Event Types.....	137
SC300 Mappings	139
I/O Board Mapping	139
Digital Output (Relay) Activation.....	141
End User License Agreement (EULA).....	142
Appendix F	149
Eaton Cybersecurity recommendations.....	149
Equipment Incident Report	156
Worldwide Support.....	159
Index	161

Overview

Topic	Page
SC300 System Controller	1
Input / Output Board	2
Connections	4
Compatible Software	4

SC300 System Controller

The SC300 system controller is an advanced control and monitoring solution which provides a full suite of communications options, including built-in Ethernet interface, Web server, Modbus, and SNMP agent.

Alarm notifications may be by Email, SNMP traps, SMS text messaging, dial-out to PowerManagerII remote monitoring software, or relay contact closures.

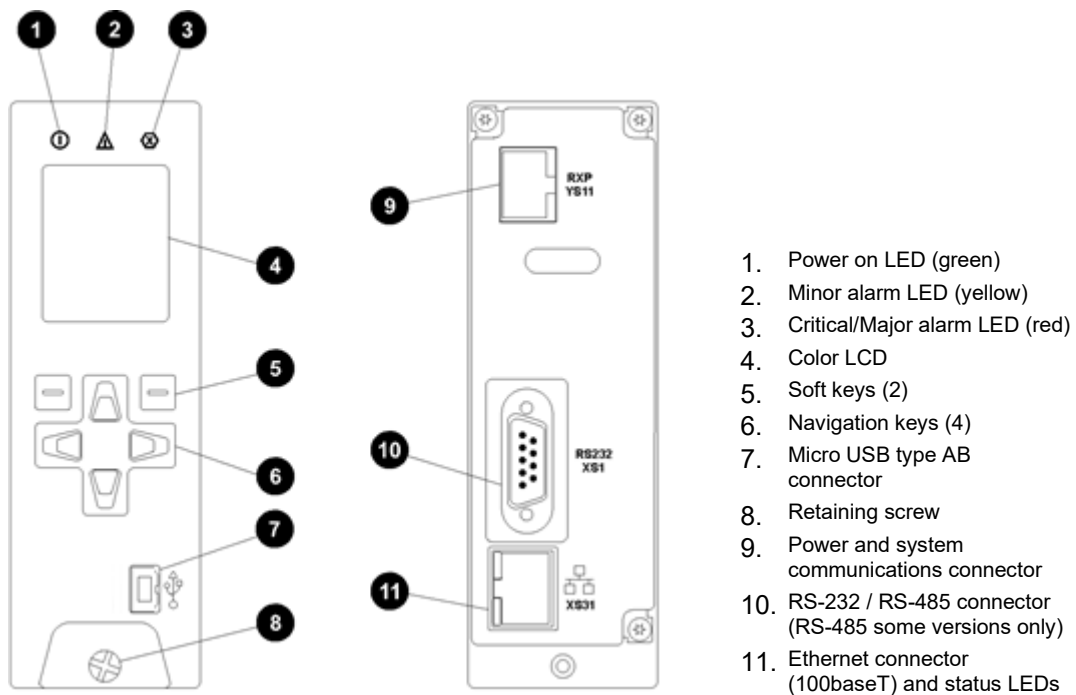

The SC300 is supplied pre-configured with either a default configuration file, or with one factory customized for a particular application. Some configuration file changes can be made with the keypad, or all settings can be changed via a PC connected to the SC300 through a network or the USB interface (see details on page 25).

For connector pin-outs see details on page 131. See Troubleshooting on page 117 for details of

SC300 alarm LEDs.

Input/Output Board

The Input / Output (I/O) board provides the I/O interfaces and connections for the SC300 system controller.

The I/O board includes a range of sense inputs for dc power system control and monitoring. It also allows real time data collection from building services and other external devices, and relay outputs for alarm signals or control of external devices.

The I/O functions are:

Sensors:	Current - 3, Bus voltage - 1, Temperature - 2, Battery Symmetry - 4
Input/Output:	Digital inputs: 4 pre-defined system functions, 6 / 9 user-defined Relay outputs: 6/8/10 (one also used as Monitor OK alarm) LVD contactor outputs: 2 or 3

 For input and output specifications see details on page 123. For connector pin-outs see details on page 132.

IO Board options include:

IOBGP-00	Uncased, 2 x LVD, 6 x relay, 6 x user DI
IOBGP-01	Cased, 2 x LVD, 6 x relay, 6 x user DI
IOBGP-10	Uncased, 3 x LVD, 10 x relay, 9 x user DI
IOBGP-11	Cased, 3 x LVD, 10 x relay, 9 x user DI
IOBGP-20	Uncased, 2 x LVD, 8 x relay, 9 x user DI
IOBGP-21	Cased, 2 x LVD, 8 x relay, 9 x user DI

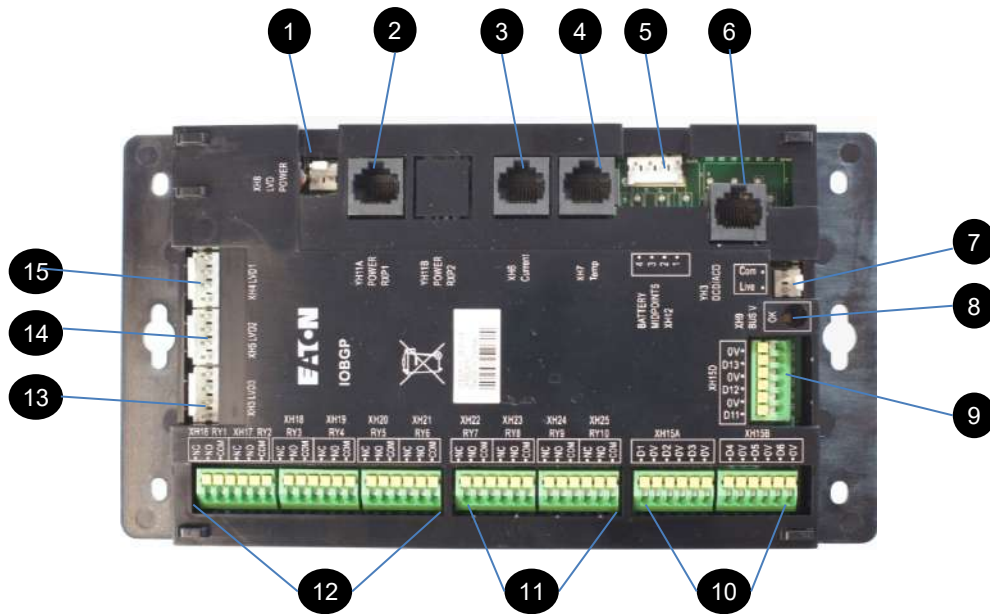

- | | |
|--|---|
| <ol style="list-style-type: none"> 1. LVD power input connector - XH8 2. Power and RXP comms input - YH11 3. Current sense inputs (3) - XH6 4. Temperature sense inputs (2) - XH7 5. Battery Symmetry Monitoring sense inputs - XH12 6. DC power system digital inputs (4 pre-defined: Load Fuse Fail, Battery Fuse Fail, AC Distribution Fan Fail, AC Distribution MOV Fail) - YH3 7. Bus voltage sense input - XH9 8. Power/Comms OK LED (green) | <ol style="list-style-type: none"> 9. Digital inputs D11-D13 (3 user defined) – XH15D <i>IOBGP-10/11/20/21 only</i> 10. Digital inputs D1-D6 (6 user defined) - XH15A, XH15B 11. Digital (relay) outputs RY7-RY10 (4) – XH22-XH25 <i>IOBGP-10/11/20/21 only</i> 12. Digital (relay) outputs RY1-RY6 (6) – XH16-XH21 13. LVD contactor 3 connector (XH3) and status LED (green) 14. LVD contactor 2 connector (XH5) and status LED (green) 15. LVD contactor 1 connector (XH4) and status LED (green) |
|--|---|

 See Troubleshooting on page 117 for details of I/O board LED signals.

Connections

The following diagram shows the connections between the SC300, the I/O board, the other dc power system components and external devices, for the IOBGP-00. Other I/O board options have additional digital inputs, outputs, and an extra LVD.

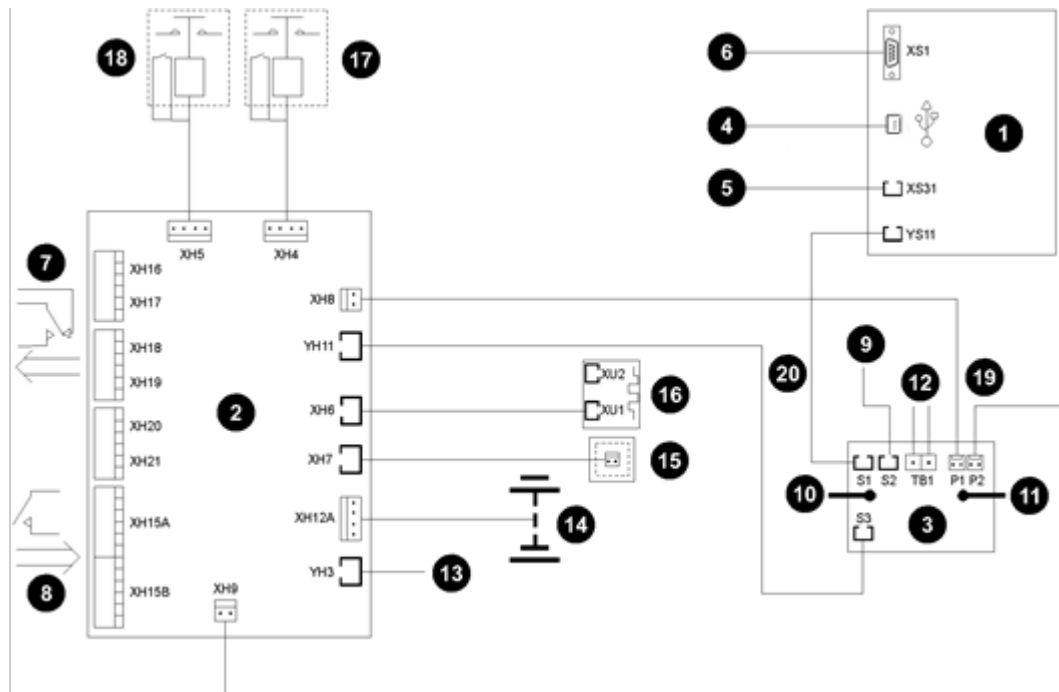

- | | |
|---|---|
| <ol style="list-style-type: none"> 1. SC300 system controller 2. I/O board (IOBGP-00/01 shown) 3. Voltage feed module 4. USB communications 5. Ethernet communications 6. RS-232 / RS-485 communications 7. Digital relay outputs to external devices and/or alarm indication system 8. Digital inputs from external voltage-free switches or relay contacts 9. Connection to additional I/O board(s) and/or SiteSure-3G I/O module(s) 10. Connection to dc common bus 11. Connection to dc live bus | <ol style="list-style-type: none"> 12. Communications to rectifiers 13. DC power system digital inputs (Load Fuse Fail, Battery Fuse Fail, AC Distribution Fan Fail, AC Distribution MOV Fail) 14. Connections for battery symmetry inputs (4) 15. Connection for temperature sensors (2) 16. Connection for current sensors (3) 17. Connection for LVD contactor and auxiliary switch 18. Connection for LVD contactor and auxiliary switch 19. Bus voltage sense and LVD power connections 20. I/O and system controller power and RXP comms connections |
|---|---|

 For connector pin-outs see details on page 132. For input and output specifications see details on page 123.

Compatible Software

The following software is compatible with the SC300 system controller:

- Recommended web browsers: Microsoft Edge, Mozilla Firefox 3.0 or later, Google Chrome.
- Any SNMP management tool or network management software
recommended: Eaton VPM / VCOM.

- PowerManagerII Remote Control and Monitoring Software. Contact your Eaton dc product supplier for further information (see Worldwide Support on page 159).
- Any Modbus master, such as a Building Management System (BMS).

Overview

Topic	Page
Starting the SC300	7
SC300 Operation using the Keypad and Screen	8
SC300 Operation Using a PC/Laptop	14
SC300 Identity Information	15
SC300 Internal Clock	17
Language Options	23
SC300 Firmware Upgrade	24
Configuration File	25
Backup and Restore	25

Starting the SC300

When dc power is applied to the SC300 (via the RXP connector YS11) the start-up sequence begins:

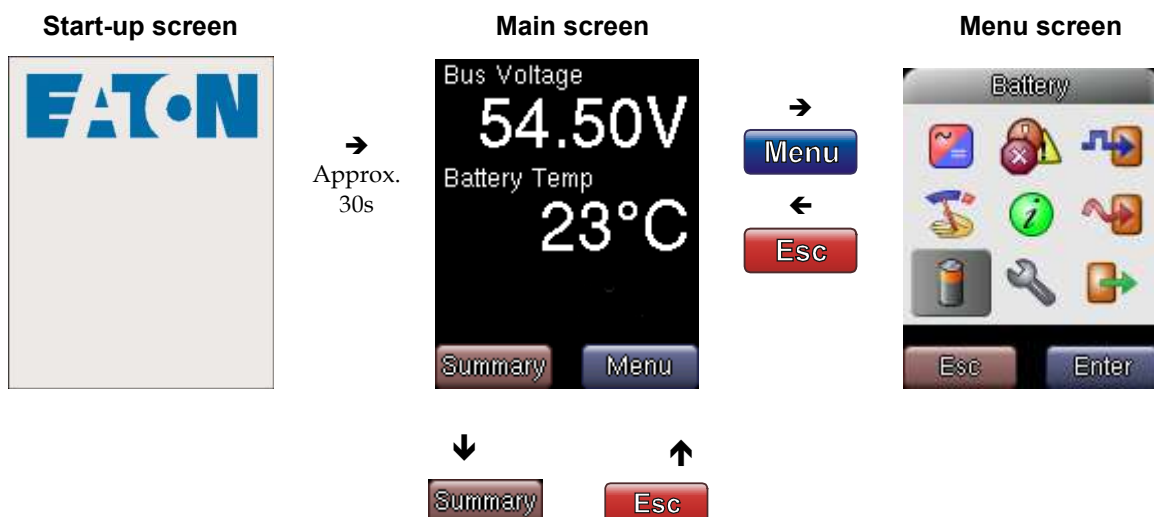

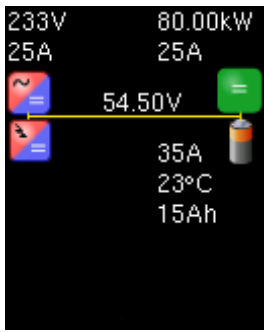





Summary screen

The values shown on the Main Screen are configurable. See details on page 12. All active Critical, Major, Minor and Warning alarms are displayed.

See navigation details on page 9. If Logon is required see Keypad Access Security on page 12.

 The display will appear some time before rack control starts and remote communications is enabled. This is a different sequence to the SC200.

Main Screen Shortcut Keys

Key	Function
	From the Main Screen go directly to the <i>Alarms</i> screen.
	From the Main Screen go directly to the <i>Settings</i> screen.
	From the Main Screen go directly to the <i>Control Processes</i> screen.
	From the Main Screen go directly to the <i>Analogs</i> screen.



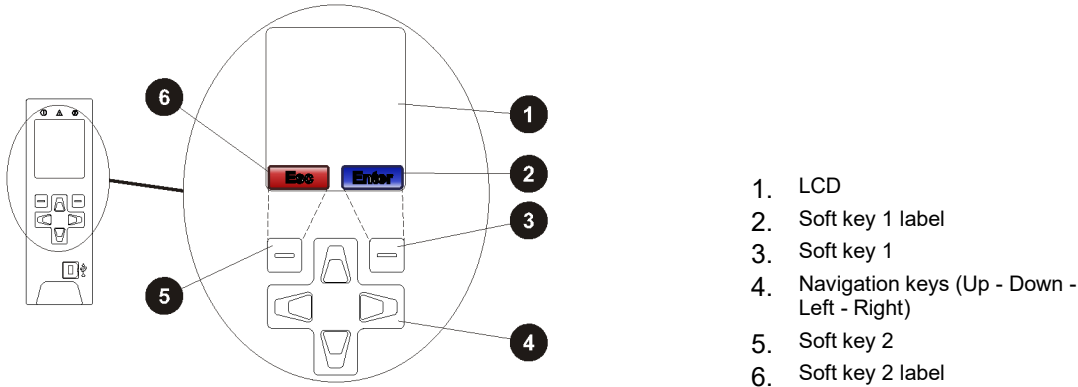



SC300 Operation using the Keypad and Screen



- 1. LCD
- 2. Soft key 1 label
- 3. Soft key 1
- 4. Navigation keys (Up - Down - Left - Right)
- 5. Soft key 2
- 6. Soft key 2 label



Soft Keys

The function of the soft keys is indicated by the corresponding labels on the LCD screen. The following table shows the most common labels and key functions.

Label	Key function
	Go to menu screen. See details on page 9.
	Go back to parent menu screen.
	Go to sub-menu or configuration screen*.
	Save a new configuration setting*.
	Ignore a new configuration setting*.
	From the Main Screen, go to the Summary Screen

* See Changing a Configuration Setting on page 11.

Navigation Keys

Key	Function
	<ul style="list-style-type: none"> • Move up/down in the menu screen. See details on page 9. • Move up/down in a list (hold to go to the top or bottom of the list). • Select options in a configuration screen. • Increase/decrease a value in a configuration screen. • From the Main Screen, press up arrow to go to <i>Active Alarms</i>, and down arrow to go to <i>Setup</i>.
	<ul style="list-style-type: none"> • Move left/right in the menu screen. See details on page 9. • Move left/right between tabs in <i>Rectifiers</i>, <i>Alarms</i>, <i>Battery</i> or <i>Settings</i> menus. • Move left/right between segments of a multiple segment value in a configuration screen. • From the Main Screen, press left arrow to go to <i>Control Processes</i>, and right arrow to go to <i>Analogs</i>.

Main Menu Navigation





At each menu screen press *Enter* to access the associated configuration menu screen(s).

 *These menus have multiple configuration menu screens. See details on page 10.*

Sub-menu Tabs

The following menu screens have sub-menus accessed via tabs at the top of the screens.

Rectifiers Sub-menus

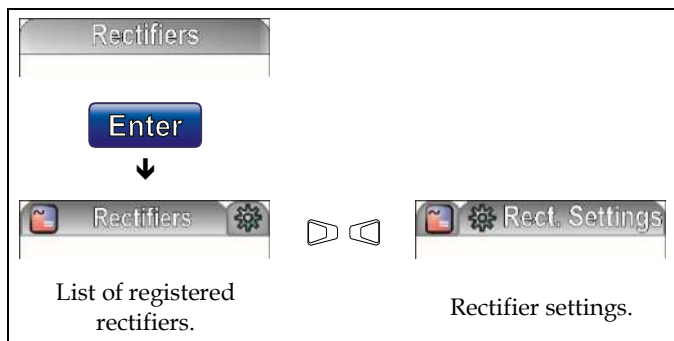

Alarms Sub-menus





Battery Sub-menus

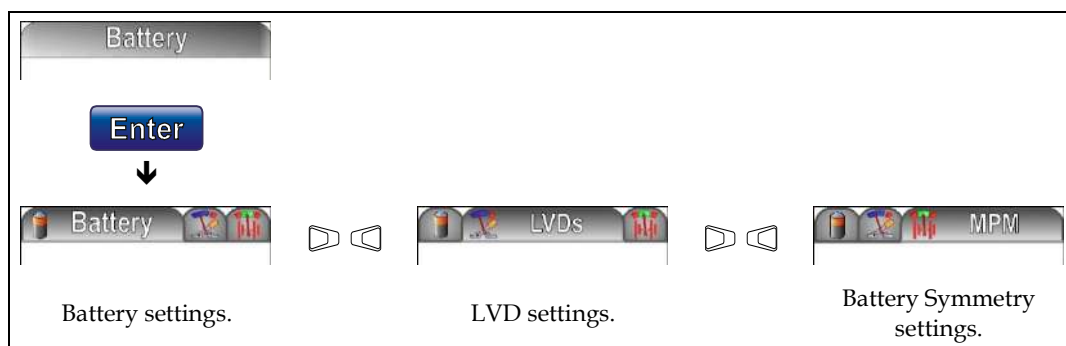

Settings Sub-menus

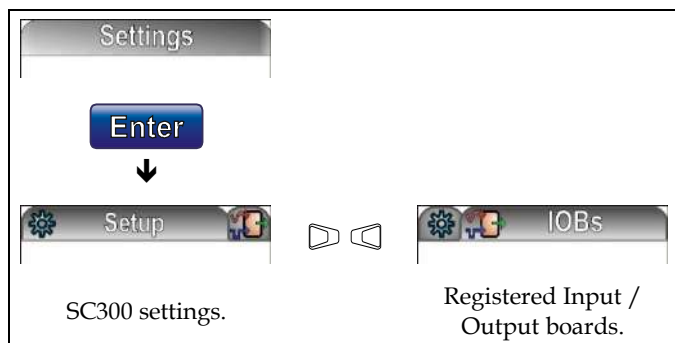

Changing a Configuration Setting using the Keypad

For the configuration settings that can be changed using the keypad, the keys have the following functions.

	Press to change the setting or activate a control process.
	Press to change the value. Hold key to change at a faster rate.
	Use these keys for values with multiple segments (for example an IP address).
	Press to save the new value.
Or	
	Press to leave the value unchanged.

Keypad Access Security

This feature prevents accidental or unauthorized changes to settings from the SC300 keypad.

	<p>All access to change an SC300's settings will be lost if:</p> <ul style="list-style-type: none"> • All communications are disabled (see S3P Access on page 114 and HTTP/HTTPS Access on page 115), and • Keypad access is <i>Read Only</i>, or <i>PIN Protected</i> and the keypad access PIN is lost. <p>The SC300 will continue to function, but no configuration changes can be made. Contact your Eaton dc product supplier or Eaton for advice (see Worldwide Support on page 159).</p>
---	---

► To use Web / DCTools to enable/disable keypad access

- In Web go to *System > Interfaces > Front Panel*.
- In DCTools, go to *Configuration > Communications > Front Panel*.
- Set *Access* to:
 - *Unprotected* - keypad access is allowed to view and change parameters, or
 - *Read Only* - keypad access is allowed to view parameters only, or
 - *PIN Protected* - keypad access is allowed to view and change parameters if the correct 4-digit number is typed in the *Access PIN* field. Otherwise, *Read Only* access is allowed.

► To use the SC300 when access is set to PIN Protected

- At the Main Screen press *Menu*. The *Logon* screen appears.
- If the *Access PIN* is not known then press *Skip* to use the SC300 with *Read Only* access.
- If the *Access PIN* is known:
 - Use the *Left* and *Right* keys to access each digit position. Use the *Up* and *Down* keys to change the digits.
 - When the correct digits are entered, press *Logon*.

 *Keypad access will return to PIN Protected mode when the display returns to the Main Screen.*

Display Settings

► To change the display contrast

- Use the keypad to go to: *Settings > Setup > Contrast > Edit*.

► To change the display language

- See Language Options on page 23.

► To change the display orientation (horizontal/vertical)

Either:

- Use the keypad to go to: *Settings > Setup > Orientation > Edit*.
- Select the required orientation (vertical, horizontal-left or horizontal-right). Press *Save*.

Or:

- In Web go to: *System > Interfaces > Physical Ports > Front Panel*.
- In DCTools, go to *Configuration > Communications > Front Panel > Physical Mounting*.
- Select the required orientation (vertical, horizontal-left or horizontal-right). Click *Apply*.

 *The functions of the navigations keys also change to suit the new display orientation.*

Main Screen Parameters

The parameters displayed on the SC300 main screen are configurable. Either two large or three small parameters can be displayed. The default settings are two large parameters with the values *Bus Voltage* and *Rectifier Current*.

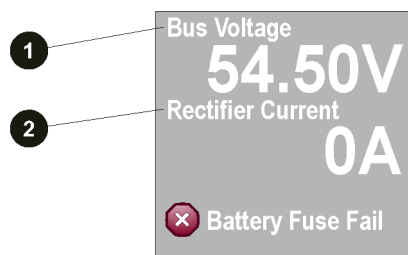

1. Value 1
2. Value 2

► To change the parameters displayed on the main screen

Either:

- Use the keypad to go to: *Settings > Setup (tab) > Display Settings > Main Screen Layout*.

Or:

- In Web go to: *System > Interfaces > Physical Ports > Front Panel*.
- In DCTools, go to *Configuration > Communications > Front Panel*.
- Set *Main Screen Layout* to *Two Large* or *Three Small*.
- Select the required parameters (see Note 1) for *Value 1* and *Value 2* (and *Value 3* if *Three Small* is selected).
- For each of *Value 1/2/3 Units*, select *No Units*, e.g. *Battery Temp. 25*, *With Value*, e.g. *Battery Temp. 25°C*, or *With Label*, e.g. *Battery Temp. (°C) 25*.
- If any of *Analog Input*, *Energy Meter*, *Power Meter*, *Current Meter*, *Voltage Meter* or *Smart Analog* are selected as a display parameter, then also select a value for *Value 1/2/3 Index*. See Note 2.

Notes:



- 1 The parameters available are: *Bus Voltage*, *Rectifier Current*, *Load Current*, *Battery Current*, *Battery Temperature*, *Load Power*, *System Power*, *Analog Input*, *Ah Discharged*, *Energy Meter*, *Power Meter*, *Current Meter*, *Smart Analog*, *Alternative Source Current*, *Solar Power*, *Generator Power*, *DCDC Voltage*, *DCDC Current*, *DCDC Power*.
- 2 If *Analog Input*, *Energy Meter*, *Power Meter*, *Current Meter*, *Voltage Meter* or *Smart Analog* is selected as a display parameter, then also select a value for *Value 1/2/3 Index*. This value is the number of the meter or input from the appropriate table.

Display Time-out

If there is no keypad activity for 60 seconds the display will go back to the main screen.

Alarm Indicators

Visual indicators

-  Power on LED (green)
-  Minor Alarm LED (yellow)

 Critical/Major Alarm LED (red)

???

The system value cannot be displayed because of a failed, disconnected or unconfigured sensor.

Audible indicator

- One beep – indicates an invalid key press
- Three beeps every 2 seconds – refer to the alert message on the display
- One beep every 2 seconds – Minor alarm is active
- Continuous sound – Critical/Major alarm is active

 *Critical/Major alarms always override Minor alarms.*

► To stop the audible indicator

- Press any key

 *The audible indicator will restart at the next active alarm or alert message.*

► To enable/disable the audible alarm indicator

Either:

- Use the keypad to go to: Alarms > Alarm Settings (tab) > Audible Alarms > Edit.

Or:

- In Web go to: *System > Interfaces > Physical Ports > Front Panel.*
- In DCTools, go to *Configuration > Communications > Front Panel.*

 *When Disabled, the audible indicator will still indicate an invalid key press.*

SC300 Operation Using a PC/Laptop

DCTools is configuration software for editing a system controller's configuration file (on-line) and monitoring the operation of Eaton's dc power systems. It is available free from dcpower.eaton.com/downloads.

DCTools can be run on a PC/laptop connected to the SC300's USB port.

 *DCTools can also be run on a remote PC/laptop connected to the SC300's RS232 serial port (via a modem) or Ethernet port. For remote PC/laptop connection details see Communications Options on page 101.*

Before you start you will need:

- The latest version of DCTools available from dcpower.eaton.com/downloads.
- A PC/laptop with USB port and USB micro cable.

 *The USB micro cable is the same as used with many smart phones.*

► To connect a PC/laptop to the SC300:

- 1 Download the latest version of DCTools from dcpower.eaton.com/downloads.
- 2 Install DCTools on the PC/laptop.
- 3 Connect a USB cable from a USB port on the PC/laptop to the USB port on the SC300.

 *See the diagram on page 1 for location of the USB port.*

- 4 DCTools will now connect to the SC300.
☐ If connection is not successful refer to DCTools Help (press F1) or Troubleshooting on page 117.
- 5 For details of the SC300 control and monitoring functions available via DCTools see System Operation on page 27.
☐ For help using DCTools press F1.

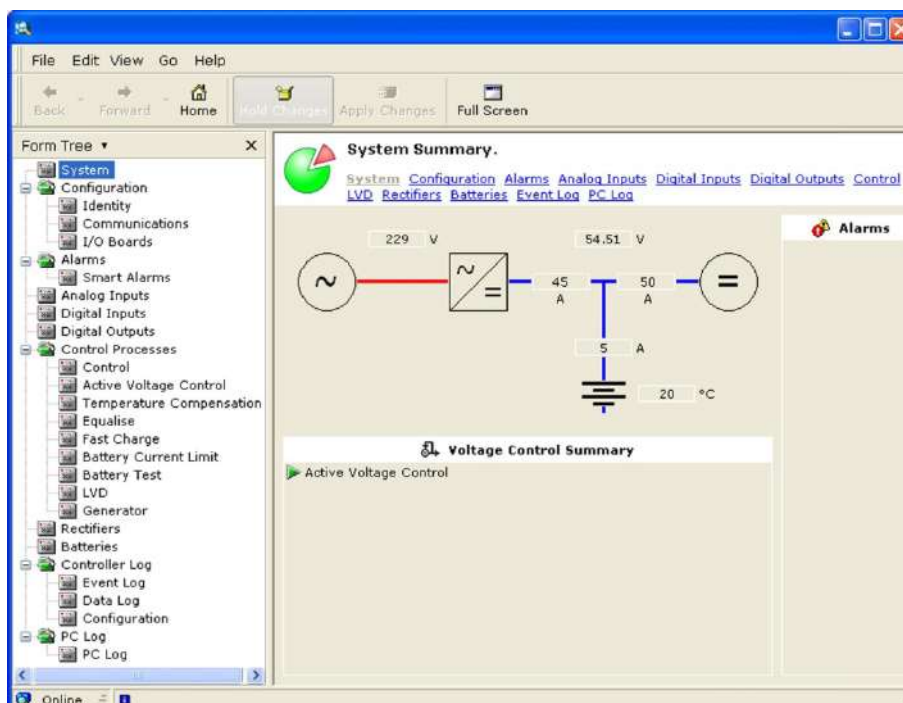

SC300 Identity Information

The following identity information is stored in the SC300.

Parameter	Description	Where to find:
Serial Number	The SC300 serial number (factory set).	SC300: Info
Software Version (App Version)	The version of the embedded software in the SC300 (factory set).	Web: Identity > Software DCTools: Configuration > Identity > Software

If required, the following site-specific information can be stored in the SC300 to assist site management.

Parameter	Description	Where to find:
System Manufacturer	The manufacturer of the dc power system.	Web: Identity
System Type	The dc power system model number.	DCTools: Configuration > Identity
System Serial Number	The dc power system serial number.	<i>Except Map Coordinates are not available in DCTools.</i>
System Location	Location of dc power system at the	

	site.
Map Coordinates	Longitude and latitude. When these values are entered, a web browser will show these coordinates on a map (using Google Maps).
Site Name	Name of the site.
Site Address	Address of the site.
Site Building	The building name.
Site Room	The equipment room name.
Site Contact	Contact details for the person in charge of the site.
Site Support Contact	Details of the person supporting this equipment.
Site Notes	Any notes relevant to site access, location or other matters.
Configuration Name	A name that can be entered for the configuration file. <i>This name is automatically loaded if the user selects a Generic System Type, or when a configuration file is loaded from web or DCTools.</i>

The following configuration information is automatically stored by the SC300:

Parameter	Description	Where to find:
Master Configuration ¹	The name of the configuration file that was last loaded into the SC300 by web interface or DCTools. A version number (such as "87668" is attached) to assist tracking of changes.	Web: Identity
Configuration Version	A unique number that is changed whenever this configuration is updated.	DCTools: Configuration > Identity
Configuration Modified	This is ticked when any settings have been changed from the last loaded configuration file.	



Generic System Types

If the user does not have a suitable configuration file for a new SC300, or he/she needs to change the operating voltage of a system, then the Generic System Types may be used as a starting point.

To select a Generic System Type, in web go to Identity > Software and select an appropriate type.

Suitable settings are then loaded into the SC300.

- *Master Configuration* takes settings back to the last configuration loaded by web or DCTools. This is useful where settings have been incorrectly changed.
- *Factory* wipes settings and resets to the normal ex-factory settings.
- *APS48V / APS24V / EPS48V LVD and EPS48V* only load settings that are specific to that voltage or system type. Other settings are left unchanged.

	The settings loaded using <i>Generic System Type</i> may not be suitable for all systems. Where possible, obtain the appropriate configuration file. After selecting a <i>Generic System Type</i> , check system operation.
	If the original configuration is corrupt or unknown, this procedure should be followed: <ol style="list-style-type: none"> 1. Load the Factory configuration 2. Load the appropriate Generic system type.
	If the factory configuration is loaded, all configuration information is lost. The SC300 IP address will revert to DHCP. This will cause remote communications to be lost if the operation is done remotely.

These are the currently available Generic System Types:

Generic System Type	Action
---------------------	--------

¹ If the current configuration is corrupted for any reason, the SC300 will revert to this configuration.

Unknown	No effect; does not change settings.
Factory	Loads the standard factory settings, except that IP addresses are not changed.
Master Config	Re-loads the last configuration file loaded by DCTools or web and saved by the SC300.
APS48V	Loads standard 48V positive earth settings. Set for 1 LVD only.
APS24V	Loads standard 24V negative earth settings Set for 1 LVD only.
EPS 48V LVD	Loads standard 48V positive earth settings. Includes an LVD.
EPS48V	Loads standard 48V positive earth settings. No LVD.

Configuration item:

Parameter	Description	Where to find:
Generic System Type	If a suitable configuration file is not available, select the appropriate system type here. This will load suitable settings into the SC300. <i>Note: ensure all settings are appropriate for the application.</i>	Web: Identity > Software DCTools: Configuration > Identity > Software

SC300 Internal Clock

The SC300 has a battery-backed clock for time stamping of log entries and Control Processes. The time and date are factory set. They can also be set manually using a web browser or can be synchronized (either to a PC clock using DCTools or to an SNTP reference time server).

► To view the SC300 time

Either:

- Use the keypad to go to: *Info*.
 - This time is shown as Universal Coordinated Time (UTC). Web and PowerManagerII convert local PC time to/from UTC for the SC300. For practical purposes UTC is equivalent to Greenwich Mean Time (GMT).
 - If a time zone has been set, the local time is also shown.

Or:

- In Web go to: *System > Time*.
- In DCTools go to: *Configuration > Time*.
 - The SC300 shows the SC300 time adjusted to the time zone set in the PC. If a local time zone has been set, this time is also shown.

Time Synchronization

If required, the SC300 time can be synchronized either to the internal time of a PC or laptop, or to a reference time server using SNTP protocol (SC300 must have access to the server).

► To synchronize the SC300 time using web

- 1 Ensure the time on the PC is correct before synchronizing.
- 2 Connect to the SC300 with web. (See Communications Options on page 101.)
- 3 Select Controller Local Time.
- 4 Enter "n" and press *Enter* to get the PC local time.
- 5 Apply changes.

► To set the time using web

Use this option if the local PC time is not correct or appropriate for the SC300 time.

- 1 Connect to the SC300 via a web browser. (See Ethernet Communications on page 101.)
- 2 Go to *System > Time*.
- 3 Click on the time-date field to select the text.
- 4 Type the correct time/date. *Note: The editing format is not the same as the display format. Enter the new date / time in the format yyyy-mm-dd hh:mm:ss.*
- 5 Press *Enter* on the keyboard. Then select *Apply* in the *Changes* window.

► To synchronize the SC300 time using DCTools

- 1 Ensure the time on the PC is correct before synchronizing.

PowerManagerII can be set to automatically synchronize SC300 clocks.
- 2 Connect to the SC300 with DCTools. (See Communications Options on page 101.)
- 3 Go to *Configuration > Time*.
- 4 Click *Synchronise* to synchronize the SC300 time to the PC/laptop time.

DCTools, Web and PowerManagerII convert local PC time to/from UTC for the SC300.

► To synchronize the SC300 time using SNTP

- SNTP is enabled by default. Default address is time.nist.gov.*
- For more information on SNTP, including a list of public SNTP servers, visit www.ntp.org*
- Ensure that your network has an internal SNTP server or allows access to an external server. It may be necessary to configure access through your network's firewall.*

- 1 Web: go to *System > Time > SNTP*.
- 2 DCTools: go to *Configuration > Time > SNTP*.
- 3 Set the following parameters:



Primary Address	IP address or name of primary SNTP server.
Backup Address	IP address or name of backup SNTP server.
UDP Port	Assigned by the time server administrator.
Poll Interval	The time between synchronizations.

- The time will update a few seconds after any SNTP parameter change.*
- The time when the time was last updated is shown on the SNTP web page.*

Internal clock battery

The SC300 uses an internal lithium battery to keep the clock running while the SC300 is not powered up. Predicted life is at least ten years. Life depends on the time the SC300 is not powered up, temperature, and battery age.

This battery is monitored by the SC300.

-  If the clock battery is low, the SC300 displays the message “RTC Battery Low” after start-up.
-  The clock battery type is Panasonic BR2330A.

To check the state of the battery:

- Web: go to *Identity > Software*.
- DCTools: go to *Configuration > Identity*.

Internal Battery Voltage provides a relative indication of battery health, not an exact voltage. A good battery should read at least 90.

If the Internal Battery Voltage is less than 90, then the SC300 will continue to work correctly and time will be correct until power is lost.



To change the clock battery, please contact your Eaton DC power representative for advice.

-  If the SC300 is running SNTP and can connect to an NTP server, then the time will be correctly synchronized regularly, even if the clock battery voltage is low.

Time Zones

The SC300 works internally with UTC (GMT).

To store logs

-  The SC300 uses UTC (GMT) for its internal time and converts for logs or display according to the Time Zone setting. If Time Zone is not set, logs are recorded in UTC only.
-  The web view shows local time for the computer running the browser.

► To set the SC300 time zone

- 1 In web, go to *Interfaces > Time > Clock*.
- 2 Select the nearest city in the list below that is in the time zone you want to set the SC300 to.
- 3 Copy the text exactly as is below into the *Time Zone* setting.
 -  There should be no spaces or carriage returns in the time zone string. Where a city name has two or more words, they are separated by an underscore _.

Africa/Abidjan	America/Goose_Bay	Asia/Aden	Europe/Athens
Africa/Accra	America/Grand_Turk	Asia/Almaty	Europe/Belgrade
Africa/Addis_Ababa	America/Grenada	Asia/Amman	Europe/Berlin
Africa/Algiers	America/Guadeloupe	Asia/Anadyr	Europe/Bratislava
Africa/Asmara	America/Guatemala	Asia/Aqtau	Europe/Brussels
Africa/Bamako	America/Guayaquil	Asia/Aqtobe	Europe/Bucharest
Africa/Bangui	America/Guyana	Asia/Ashgabat	Europe/Budapest
Africa/Banjul	America/Halifax	Asia/Atyrau	Europe/Busingen
Africa/Bissau	America/Havana	Asia/Baghdad	Europe/Chisinau
Africa/Blantyre	America/Hermosillo	Asia/Bahrain	Europe/Copenhagen

Africa/Brazzaville	America/Indiana/Indianapolis	Asia/Baku	Europe/Dublin
Africa/Bujumbura	America/Indiana/Knox	Asia/Bangkok	Europe/Gibraltar
Africa/Cairo	America/Indiana/Marengo	Asia/Barnaul	Europe/Guernsey
Africa/Casablanca	America/Indiana/Petersburg	Asia/Beirut	Europe/Helsinki
Africa/Ceuta	America/Indiana/Tell_City	Asia/Bishkek	Europe/Isle_of_Man
Africa/Conakry	America/Indiana/Vevay	Asia/Brunei	Europe/Istanbul
Africa/Dakar	America/Indiana/Vincennes	Asia/Chita	Europe/Jersey
Africa/Dar_es_Salaam	America/Indiana/Winamac	Asia/Choibalsan	Europe/Kaliningrad
Africa/Djibouti	America/Inuvik	Asia/Colombo	Europe/Kiev
Africa/Douala	America/Iqaluit	Asia/Damascus	Europe/Kirov
Africa/El_Aaiun	America/Jamaica	Asia/Dhaka	Europe/Lisbon
Africa/Freetown	America/Juneau	Asia/Dili	Europe/Ljubljana
Africa/Gaborone	America/Kentucky/Louisville	Asia/Dubai	Europe/London
Africa/Harare	America/Kentucky/Monticello	Asia/Dushanbe	Europe/Luxembourg
Africa/Johannesburg	America/Kralendijk	Asia/Famagusta	Europe/Madrid
Africa/Juba	America/La_Paz	Asia/Gaza	Europe/Malta
Africa/Kampala	America/Lima	Asia/Hebron	Europe/Mariehamn
Africa/Khartoum	America/Los_Angeles	Asia/Ho_Chi_Minh	Europe/Minsk
Africa/Kigali	America/Lower_Princes	Asia/Hong_Kong	Europe/Monaco
Africa/Kinshasa	America/Maceio	Asia/Hovd	Europe/Moscow
Africa/Lagos	America/Managua	Asia/Irkutsk	Europe/Oslo
Africa/Libreville	America/Manaus	Asia/Jakarta	Europe/Paris
Africa/Lome	America/Marigot	Asia/Jayapura	Europe/Podgorica
Africa/Luanda	America/Martinique	Asia/Jerusalem	Europe/Prague
Africa/Lubumbashi	America/Matamoros	Asia/Kabul	Europe/Riga
Africa/Lusaka	America/Mazatlan	Asia/Kamchatka	Europe/Rome
Africa/Malabo	America/Menominee	Asia/Karachi	Europe/Samara
Africa/Maputo	America/Merida	Asia/Kathmandu	Europe/San_Marino
Africa/Maseru	America/Metlakatla	Asia/Khandyga	Europe/Sarajevo
Africa/Mbabane	America/Mexico_City	Asia/Kolkata	Europe/Saratov
Africa/Mogadishu	America/Miquelon	Asia/Krasnoyarsk	Europe/Simferopol
Africa/Monrovia	America/Moncton	Asia/Kuala_Lumpur	Europe/Skopje
Africa/Nairobi	America/Monterrey	Asia/Kuching	Europe/Sofia
Africa/Ndjamena	America/Montevideo	Asia/Kuwait	Europe/Stockholm
Africa/Niamey	America/Montreal	Asia/Macau	Europe/Tallinn
Africa/Nouakchott	America/Montserrat	Asia/Magadan	Europe/Tirane
Africa/Ouagadougou	America/Nassau	Asia/Makassar	Europe/Ulyanovsk
Africa/Porto-Novo	America/New_York	Asia/Manila	Europe/Uzhgorod
Africa/Sao_Tome	America/Nipigon	Asia/Muscat	Europe/Vaduz
Africa/Tripoli	America/Nome	Asia/Nicosia	Europe/Vatican
Africa/Tunis	America/Noronha	Asia/Novokuznetsk	Europe/Vienna
Africa/Windhoek	America/North_Dakota/Be	Asia/Novosibirsk	Europe/Vilnius

	ulah		
America/Adak	America/North_Dakota/Ce nter	Asia/Omsk	Europe/Volgograd
America/Anchorage	America/North_Dakota/Ne w_Salem	Asia/Oral	Europe/Warsaw
America/Anguilla	America/Nuuk	Asia/Phnom_Penh	Europe/Zagreb
America/Antigua	America/Ojinaga	Asia/Pontianak	Europe/Zaporozhye
America/Araguaina	America/Panama	Asia/Pyongyang	Europe/Zurich
America/Argentina/Buen os_Aires	America/Pangnirtung	Asia/Qatar	Indian/Antananarivo
America/Argentina/Cata marca	America/Paramaribo	Asia/Qyzylorda	Indian/Chagos
America/Argentina/Cord oba	America/Phoenix	Asia/Riyadh	Indian/Christmas
America/Argentina/Jujuy	America/Port-au-Prince	Asia/Sakhalin	Indian/Cocos
America/Argentina/La_Ri oja	America/Port_of_Spain	Asia/Samarkand	Indian/Comoro
America/Argentina/Mend oza	America/Porto_Velho	Asia/Seoul	Indian/Kerguelen
America/Argentina/Rio_ Gallegos	America/Puerto_Rico	Asia/Shanghai	Indian/Mahe
America/Argentina/Salta	America/Punta_Arenas	Asia/Singapore	Indian/Maldives
America/Argentina/San_J uan	America/Rainy_River	Asia/Srednekolymsk	Indian/Mauritius
America/Argentina/San_L uis	America/Rankin_Inlet	Asia/Taipei	Indian/Mayotte
America/Argentina/Tucu man	America/Recife	Asia/Tashkent	Indian/Reunion
America/Argentina/Ushu aia	America/Regina	Asia/Tbilisi	Pacific/Apia
America/Aruba	America/Resolute	Asia/Tehran	Pacific/Auckland
America/Asuncion	America/Rio_Branco	Asia/Thimphu	Pacific/Bougainville
America/Atikokan	America/Santarem	Asia/Tokyo	Pacific/Chatham
America/Bahia	America/Santiago	Asia/Tomsk	Pacific/Chuuk
America/Bahia_Banderas	America/Santo_Domingo	Asia/Ulaanbaatar	Pacific/Easter
America/Barbados	America/Sao_Paulo	Asia/Urumqi	Pacific/Efate
America/Belem	America/Scoresbysund	Asia/Ust-Nera	Pacific/Enderbury
America/Belize	America/Sitka	Asia/Vientiane	Pacific/Fakaofu
America/Blanc-Sablon	America/St_Barthelemy	Asia/Vladivostok	Pacific/Fiji
America/Boa_Vista	America/St_Johns	Asia/Yakutsk	Pacific/Funafuti
America/Bogota	America/St_Kitts	Asia/Yangon	Pacific/Galapagos
America/Boise	America/St_Lucia	Asia/Yekaterinburg	Pacific/Gambier
America/Cambridge_Bay	America/St_Thomas	Asia/Yerevan	Pacific/Guadalcanal
America/Campo_Grande	America/St_Vincent	Atlantic/Azores	Pacific/Guam
America/Cancun	America/Swift_Current	Atlantic/Bermuda	Pacific/Honolulu
America/Caracas	America/Tegucigalpa	Atlantic/Canary	Pacific/Kiritimati
America/Cayenne	America/Thule	Atlantic/Cape_Verde	Pacific/Kosrae
America/Cayman	America/Thunder_Bay	Atlantic/Faroe	Pacific/Kwajalein
America/Chicago	America/Tijuana	Atlantic/Madeira	Pacific/Majuro

America/Chihuahua	America/Toronto	Atlantic/Reykjavik	Pacific/Marquesas
America/Costa_Rica	America/Tortola	Atlantic/South_Georgia	Pacific/Midway
America/Creston	America/Vancouver	Atlantic/St_Helena	Pacific/Nauru
America/Cuiaba	America/Whitehorse	Atlantic/Stanley	Pacific/Niue
America/Curacao	America/Winnipeg	Australia/Adelaide	Pacific/Norfolk
America/Danmarkshavn	America/Yakutat	Australia/Brisbane	Pacific/Noumea
America/Dawson	America/Yellowknife	Australia/Broken_Hill	Pacific/Pago_Pago
America/Dawson_Creek	Antarctica/Casey	Australia/Currie	Pacific/Palau
America/Denver	Antarctica/Davis	Australia/Darwin	Pacific/Pitcairn
America/Detroit	Antarctica/DumontDURville	Australia/Eucla	Pacific/Pohnpei
America/Dominica	Antarctica/Macquarie	Australia/Hobart	Pacific/Port_Moresby
America/Edmonton	Antarctica/Mawson	Australia/Lindeman	Pacific/Rarotonga
America/Eirunepe	Antarctica/McMurdo	Australia/Lord_Howe	Pacific/Saipan
America/El_Salvador	Antarctica/Palmer	Australia/Melbourne	Pacific/Tahiti
America/Fort_Nelson	Antarctica/Rothera	Australia/Perth	Pacific/Tarawa
America/Fortaleza	Antarctica/Syowa	Australia/Sydney	Pacific/Tongatapu
America/Glace_Bay	Antarctica/Troll	Europe/Amsterdam	Pacific/Wake
America/Godthab	Antarctica/Vostok	Europe/Andorra	Pacific/Wallis
America/Goose_Bay	Arctic/Longyearbyen	Europe/Astrakhan	

Language Options

The SC300 system controller language default is English.

It can be configured to display web pages and the display in other languages.

Language selection

► To select a new language for the Web pages

- On the *Log On* web page, before logging on, click on the language drop down box and select the required language.
- The web pages will change to this language.

► To select a new language for the SC300 display

- On the SC300 keypad go to: *Settings > Language > Edit*.
- Select the required language and press *Save* (displayed in the selected language).

SC300 Firmware Upgrade

If required, the embedded software (firmware) in the SC300 can be upgraded from a PC/laptop via a web browser or via USB.



This process applies **only to upgrading SC300 software version 1.14 or later**. To upgrade earlier versions, refer to PRN0135 SC300 System Controller Version 1.14. This document and the related upgrade files are available on request from Eaton.

If versions of software before 1.14 are upgraded using incorrect files the software may become unusable and require replacement or return to Eaton for repair.

► To use a web browser for a Firmware Upgrade

- 1 Connect to the SC300 via a web browser. (For details see Ethernet Communications on page 101.)
- 2 Check the SC300 internal clock shows the correct time. If necessary, set the correct time. See SC300 Internal Clock on page 17.
- 3 Go to *Tools*.
- 4 Select *Firmware Upgrade: Launch*.
- 5 Select the file (*.icp). Click *Next*, then click *Proceed*.

► To use USB for a Firmware Upgrade

A USB upgrade may be slightly quicker than web and does not require an Ethernet connection, but does require a special software tool.

- 1 Back up the SC300 configuration using web or DCTools.
- 2 If it is not already installed, install Tera Term. This is a free terminal emulator, available from Tera Term <https://ttssh2.osdn.jp/index.html.en>.
- 3 Close DCTools if it is running. Ensure the Connection Manager icon in the Taskbar is closed.
- 4 Apply power to the SC300 while holding down any front panel key.
- 5 Wait until the SC300 shows a screen showing start-up options (Down... Right... Other key...).
- 6 Press the right arrow to select USB ZModem Upgrade.
- 7 The SC300 should now show USB ZModem Upgrade.
- 8 Connect to the SC300 via USB.

- 9 Start Tera Term.
- 10 Select *File > New Connection*.
- 11 Select *Serial*.
- 12 Select a Port. A new “virtual” com port number should be shown. Choose this port.
- 13 Select *OK*.
- 14 Select *File > Transfer > Zmodem > Send* and select the appropriate upgrade file supplied by Eaton.
- 15 Select *Open*. The upgrade will proceed.
- 16 Wait until the SC300 has restarted.
- 17 From the front panel, select *Menu > i* to check the configuration has succeeded.
- 18 Verify the configuration settings.



Some configuration settings may be lost when the firmware in the SC300 is upgraded. Refer to the new firmware Product Release Notes for details of specific configuration settings that are affected. Check the configuration after upgrading.
Before starting the upgrade, back up any changes to the configuration.

Configuration File

The operational settings of the dc power system are stored in a configuration file loaded into the SC300 system controller.

The SC300 is supplied pre-loaded with a configuration file. If this configuration file has been customized for the site, then no further configuration changes will be necessary.

Otherwise, it is important that the settings of this configuration file are checked and changed as required for site-specific conditions. In particular, settings that may affect the performance and life expectancy of the battery must be checked and set according to the battery manufacturer’s recommendations.

Some settings in the configuration file can be edited using the system controller's keypad (see details on page 8), or all settings can be edited using a PC/laptop with DCTools (see details on page 14) or remotely, see Communications Options on page 101.

The configuration file settings in the SC300 can be saved to (Backup) or loaded from (Restore) a PC/laptop using Web or DCTools. See Backup and Restore on page 25.



Refer to SC300 Identity Information on page 15 for more information on configuration settings and values.

Backup and Restore

The configuration file settings in the SC300 can be saved to (Backup) or loaded from (Restore) a PC/laptop using Web or DCTools.

Backup and Restore can be used to:

- Load a standard (master) configuration file into an SC300 for customization.
- Copy a customized configuration file from one SC300 to others (at similar sites).
- Save a copy of a customized configuration file. This is recommended in case the SC300 has to be replaced.

► To use Web for Backup

- 1 Connect to the SC300 via a web browser. For details see Ethernet Communications on page 101.
- 2 Go to *Tools*.
- 3 Select *Backup Tool*.
- 4 Select the file type:
 - **System Snapshot (*.dcs):** Configuration file including site specific settings.
 - **Configuration (*.dcc):** Configuration file without site specific settings - Site Identity, IP Address, S3P Address, battery characterization data).
- 5 Click *Proceed* to back up the configuration.



► **To use Web for Restore**

- 1 Connect to the SC300 via a web browser. For details see Ethernet Communications on page 101.
- 2 Go to *Tools*.
- 3 Select *Restore Tool*.
- 4 Select the file type:
 - **System Snapshot (*.dcs):** Configuration file including site specific settings.
 - **Configuration (*.dcc):** Configuration file without site specific settings - Site Identity, IP Address, S3P Address, battery characterization data).
 - **Fragment (*.dcf):** Restore part of a configuration file (such as battery characterization data).
- 5 Click *Next*, and then select a file name to *Restore* a configuration.

► **To use DCTools for backup and restore**

- 1 Connect to the SC300 with DCTools. See Communications Options on page 101.
 - 2 In DCTools go to *File > ICE Backup/Restore* and follow the prompts.
-  *The saved file does not include site specific settings including Site Identity, IP Address, S3P Address, battery characterization data.*

► **To load configuration files from SC200 or older SC300 versions**

-  *This is useful when it is required to update an SC200 configuration file to use in an SC300.*
-  *Passwords are **not** copied from the SC200. These will need to be re-entered.*
-  *Loading an older configuration file does not clear new configuration items. This means that new items could possibly be set to inappropriate values. Unless the SC300 is new (in which case the configuration items are set to safe defaults), it is highly recommended to clear the new SC300 items to defaults using this process:*
- 1 In web or DCTools, go to *Identity > Software*.
 - 2 Set *Generic System Type* to *Factory*, and apply this change.
 - 3 Restore the old configuration using the web or DCTools as above. The older configuration is automatically updated to SC300 format and loaded.
 - 4 Check the SC300 settings and operation.
 - 5 Backup the new SC300 configuration file using the process above.

Overview

Topic	Page
Voltage Control	27
Rectifiers	39
Low Voltage Disconnect (LVD)	45
Alarms	52
Batteries	65
Generator Control	75
Alternative Energy Input Metering	79
Input / Output (I/O)	79
Data Logging	94

Voltage Control

The output voltage of the rectifiers is controlled by a number of control processes. The following diagram shows the various control processes, measured values and operating values that determine the rectifier output voltage.

- ☐ *If ac fails then any active control process stops. No control process can start until the ac supply is restored.*

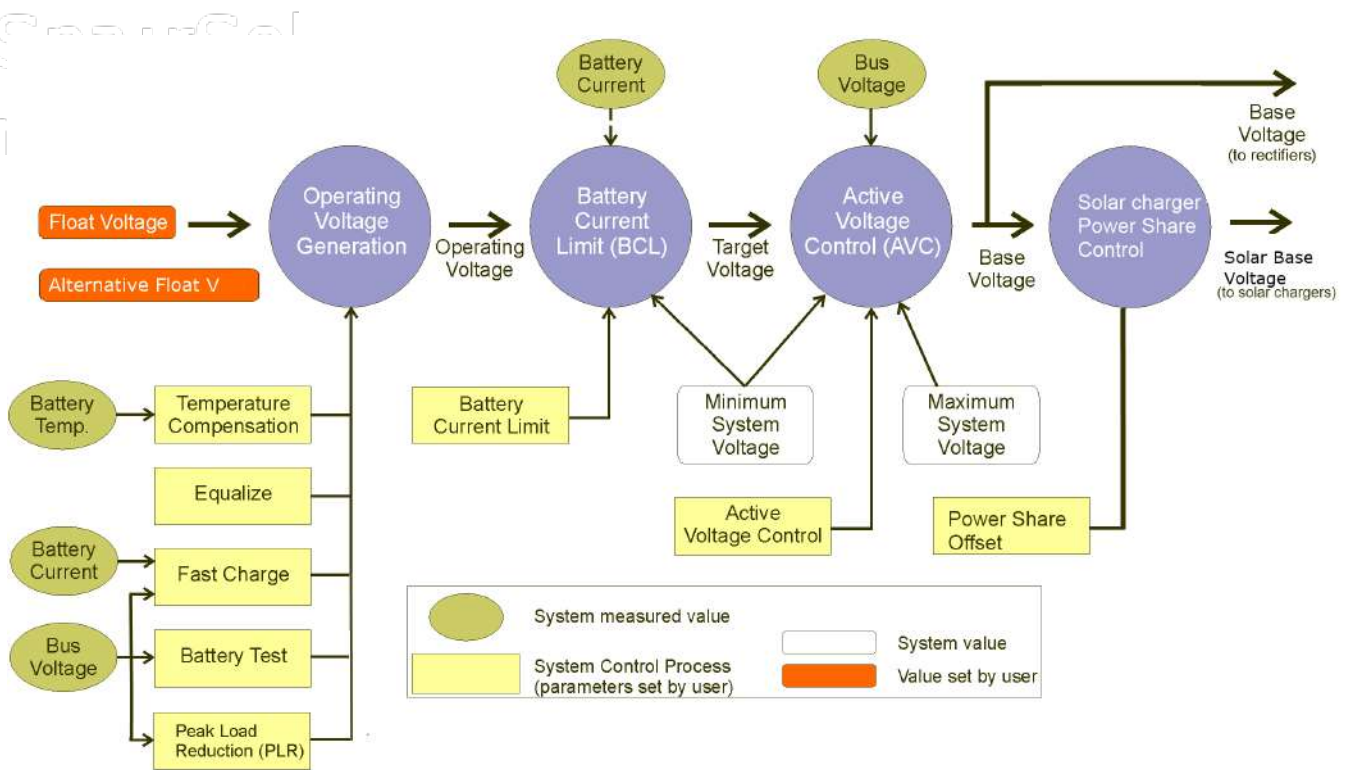



Figure 1 Voltage control overview

Float Voltage

Float voltage is the standard output voltage of the system. This may be modified by the various control processes.

Configuration

Set the following parameter.

Parameter	Description	Where to find:
Float Voltage	Set to the voltage required to maintain optimum battery charge (at the nominal ambient temperature*) as specified by the battery manufacturer. The bus voltage may be adjusted above or below this value by the System Control Processes.	SC300: Control Processes > Voltage Control > Float Voltage
	 *This is the same as the Reference Temperature used by Temperature Compensation. See details on page 35.	Web: Control Processes > Voltages
Alternative Float Voltage	When Alternative Float Smart Alarm is active, the float voltage is changed to this value.	DCTools: > Voltage Control
Alternative Float Smart Alarm	When Alternative Float Smart Alarm is active, the float voltage is changed to Alternative Float Voltage.	

 The system voltage is limited by maximum and minimum values. The values are viewable in DCTools/Web at Control Processes > Voltage Control. These values are not configurable by Web or DCTools. If these must be changed, contact your Eaton representative for a changed

configuration file or access to ICE software.

Alternative Float Voltage

Alternative Float Voltage is an alternative operating voltage that can be used in particular circumstances, particularly when a special battery charging regime is used.

When *Alternative Float Smart Alarm* is active, *Alternative Float Voltage* will be used instead of Float Voltage.

Configuration

Set the following parameters.

Parameter	Description	Where to find:
Alternative Float Voltage	When <i>Alternative Float Smart Alarm</i> is active, the float voltage is changed to this value.	SC300: Control Processes > Voltage Control > Float Voltage
Alternative Float Smart Alarm	When <i>Alternative Float Smart Alarm</i> is active, the float voltage is changed to <i>Alternative Float Voltage</i> .	Web: Control Processes > Voltages DCTools: > Voltage Control

The system voltage is limited by maximum and minimum system values. The values are viewable in DCTools/Web at Control Processes. These values are not configurable by Web or DCTools. If these must be changed, contact your Eaton representative for access to ICE software.

Active Voltage Control (AVC)

Active Voltage Control maintains a constant float voltage under varying load current by monitoring the bus voltage and adjusting the rectifier output voltage to compensate for any voltage drop. This prevents undercharging the batteries during high load demand.

AVC controls both AC rectifiers and solar chargers, so that the same bus voltage is maintained, irrespective of the energy source.

► To enable Active Voltage Control

- Use the SC300 keypad to go to: Control Processes > Voltage Control > AVC.
- In Web / DCTools go to: Control Processes > Active Voltage Control.

Active Voltage Control is normally enabled. Only disable it for a specific reason.

Information

The following information is available about AVC.

Parameter	Description	Where to find:
State	Indicates if AVC is active or inactive.	
Target Voltage	AVC will set the Base Voltage to attempt to maintain the bus voltage to this value.	Web/DCTools: Control Processes > Active Voltage Control
Voltage Offset	The difference between the Base Voltage and the Target Voltage.	

Battery Current Limit (BCL)

Battery Current Limit automatically limits the battery recharge current to:

- Prevent excessive battery charge current in under-loaded systems
- Minimize gas release in VRLA batteries
- Reduce the load on a standby generator.

Two current limit values can be set (both are a percentage of the C10 rating of the battery):

Battery Current Limit (Normal Limit): BCL value for use when utility ac is available.

Engine Run Limit (optional): BCL value for use when ac is supplied by a standby generator. This reduces the load on the generator and allows a smaller generator to be used.

 *Engine Run Limit applies when the SC300 determines that an ac standby generator is running. If an Engine Run Digital Input is available (see below), then the SC300 uses this to determine if the generator is running. If an Engine Run Digital Input is not available, then the SC300 uses other values to determine if the generator is running.*

► **To enable BCL**

- Use the SC300 keypad to go to: *Control Processes > Battery Current Limit.*
- In Web go to: *Control Processes > BCL.*
- In DCTools go to: *Control Processes > Battery Current Limit.*

► **To activate Engine Run BCL**

- If an Engine Run Digital Input is required, connect a voltage free relay contact (that will operate when the standby generator starts) to a Digital Input.
- In Web/DCTools go to *Digital Inputs.*
- Configure the selected Digital Input and set *Function* to *Engine Run.*
- In Web/DCTools go to *Control Processes > Battery Current Limit(or BCL)* and set the *Engine Run Limit.*

Information

The following information is available about BCL.

Parameter	Description	Where to find:
State	Indicates if BCL is active or inactive.	SC300: Control Processes > Battery Current Limit. Web: Control Processes > BCL DCTools: Control Processes > Battery Current Limit
Engine Run State	Indicates if Engine Run BCL is active.	Web: Control Processes > BCL
Voltage Offset	The bus voltage adjustment made by Battery Current Limit is applied to the Operating Voltage to produce the Target Voltage. Target Voltage is used as the input to the AVC function.	DCTools: Control Processes > Battery Current Limit

Configuration

Set the following parameters.

Parameter	Description	Where to find:
Battery Capacity	Set to the rated 10 hour capacity of the installed battery strings. Zero means no battery is installed.	SC300: Battery > Battery > Battery Capacity DCTools/Web: Batteries
Normal Limit	BCL maintains the battery current below this value, which is a percentage of the installed C10 Battery Capacity.	Web: Control Processes > BCL DCTools:
Engine Run Limit	The Battery Current Limit setting when Engine Run State is active.	Control Processes > Battery Current Limit

Battery Test

Battery Test is a preventative maintenance tool that monitors the discharge capabilities to ensure that the condition of the battery has not deteriorated over time.

The SC300 temporarily reduces the output voltage of the rectifiers to just below the bus voltage for a set duration. The battery then supplies power to the load. A battery test passes if the battery voltage remains above a predetermined level for the duration of the test.

Battery Tests can be scheduled to occur at regular intervals, and/or can be started/stopped manually, and/or can be started by an external relay contact or switch.

- Battery Test does **NOT** function during a Fast Charge or Equalize, or during the lock-out period after an ac supply failure.
- If a Digital Input has the function "Start Battery Test" then a Battery Test will start when the Digital Input becomes active.

► To enable Battery Test (or to start or stop a test manually)

- Use the SC300 keypad to go to: *Control Processes > Battery Test*.
- Or, in DCTools/Web go to: *Control Processes > Battery Test*

► To use an external relay contact to activate a Battery Test (optional)

- Connect a voltage free relay contact or switch to any Digital Input.
- In DCTools/Web go to *Digital Inputs*.
- Configure the selected Digital Input and set *Function* to *Start Battery Test*.

Information

The following information is available about Battery Test.

Parameter	Description	Where to find:
State	Indicates if Battery Test is disabled, locked-out, active or inactive.	
Next Start Time	The start time of the next scheduled Battery Test. <input type="checkbox"/> Time shown on SC300 is UTC. Time on PC running DCTools/Web is local time. See SC300 Internal Clock on page 17.	SC300: Control Processes > Battery Test DCTools/Web: Control Processes > Battery Test
Remaining Time	The time to the end of the currently active Battery Test.	
Battery Test Lockout Remaining	The time remaining until a Battery Test can be started. Battery Tests cannot be started within 48 hours of an ac	

	supply failure. Lockout can be disabled by temporarily setting <i>Interval</i> to 0d.
Voltage Offset	The adjustment to the bus voltage being applied due to the Battery Test. While a Battery Test is running, the rectifiers are turned down to force the battery to carry the load.

Configuration

Set the following parameters.

Parameter	Description	Where to find:
First Start Time	The date and time that the first battery test cycle will occur. Subsequent tests will occur at every Battery Test Interval after that.	
Interval	The time between scheduled battery tests. The interval period begins at the start of a battery test. Zero disables scheduled battery tests. Zero also disables the 48 hour lockout following an ac supply failure, allowing an immediate manual test.	SC300: Control Processes > Battery Test
Test Duration	The maximum time a Battery Test process will be active. The battery test will pass if the bus voltage remains above the Battery Test Termination Voltage for the duration of the test.	DCTools/Web: Control Processes > Battery Test
Termination Voltage	If the bus voltage drops below this value during a Battery Test, then the test fails.	
Prevent Battery Test	Choose whether the alarm Battery Fuse Fail should prevent Battery Test starting.	
Allow Battery Test During Lockout	Click on this to allow an immediate manual battery test before the 48 hour lockout period.	
Reset Battery Test Fail	Reset the Batttery Test Fail alarm.	

Equalize

Equalize charges batteries at a higher voltage after they have been fully charged to ensure that all individual cell voltages are the same, that electrolyte is distributed evenly, and that sulfate crystal buildup on the plates is reduced.

Equalize can be scheduled to occur at regular intervals and/or can be started/stopped manually.

- Refer to the battery manufacturer's instructions before using Equalize.
- If a Digital Input has the function "Start Equalize" then a manual equalize cycle will start when the Digital Input becomes active.

If Equalize cannot start at the scheduled time (for example when there is no ac supply) then its state will be Pending, and it will start as soon as conditions allow. Use Stop Equalize to cancel a Pending Equalize.

► To enable Equalize (or to start or stop Equalize manually)

- Use the SC300 keypad to go to: *Control Processes > Equalize*.
- Or, in DCTools/Web go to: *Control Processes > Equalize*.

► To use an external relay contact to activate Equalize (optional)

- Connect a voltage free relay contact or switch to any Digital Input.
- In DCTools/Web go to: *Digital Inputs*.
- Configure the selected Digital Input and set *Function* to *Start Equalize*.
- ▶ **To use a Smart Alarm to activate Equalize (optional)**
- Configure a Smart Alarm as required to activate Equalize.
- Set *Activating Smart Alarm* to the Smart Alarm Number.

Information

The following information is available about Equalize.

Parameter	Description	Where to find:
State	Indicates if Equalize is Disabled, Active, Inactive or Pending.	
Next Start Time	The start time of the next scheduled Equalize.  <i>Time shown on the SC300 is UTC (GMT). Time shown on a PC running web or DCTools is local time. See SC300 Internal Clock on page 17.</i>	SC300: Control Processes > Equalize DCTools/Web: Control Processes > Equalize
Remaining Time	The time to the end of the currently active Equalize.	
Voltage Offset	The adjustment to the bus voltage being applied due to the Equalize.	

Configuration

Set the following parameters.

Parameter	Description	Where to find:
First Start Time	The date and time that the first scheduled Equalize will occur. Subsequent Equalize will occur at every Equalize Interval after that.	
Interval	The time between scheduled Equalize. The interval period begins at the start of an Equalize. Zero disables scheduled Equalizes.	
Duration	The duration of a scheduled Equalize. Use the value recommended by the battery manufacturer.	SC300: Control Processes > Equalize DCTools/Web: Control Processes > Equalize
Equalize Voltage	The bus voltage maintained during an Equalize cycle. Use the value recommended by the battery manufacturer. The bus voltage is further adjusted by Temperature Compensation.	
Activating Smart Alarm	If this is set to a number other than zero, activation of this Smart Alarm number will start an Equalize cycle.	

 *Equalize may also be used to trigger the Generator Control Output. See details on page 75.*

Fast Charge

Fast Charge automatically increases the float voltage of the power system to recharge the

batteries as quickly as possible after a prolonged battery discharge.

- Fast Charge does NOT function during a Battery Test, Equalize or if the battery current sensor fails.*
- If Fast Charge is used, then Battery Current Limit (BCL) should also be used. See Battery Current Limit on page 29 for details.*

If Fast Charge cannot start at the scheduled time (for example when there is no ac supply) then its state will be Pending, and it will start as soon as conditions allow. Use Stop Fast Charge to cancel a Pending Fast Charge.

► **To enable Fast Charge (or to stop Fast Charge manually)**

- Use the SC300 keypad to go to: *Control Processes > Fast Charge.*
- Or, in Web / DCTools go to: *Control Processes > Fast Charge.*

Information

The following information is available about Fast Charge.

Parameter	Description	Where to find:
State	Indicates if Fast Charge is Disabled, Active, Inactive or Pending.	
Ah Discharged	The current level of battery discharge. A Fast Charge cycle is started if this value is above the Ah Threshold. <input type="checkbox"/> <i>See also Reset Battery State on page 73.</i>	SC300: Control Processes > Fast Charge DCTools/Web: Control Processes > Fast Charge
Maximum Time Remaining	The maximum time to the end of the currently active Fast Charge.	
Voltage Offset	The adjustment to the bus voltage being applied due to the Fast Charge.	

Configuration

Set the following parameters.

Parameter	Description	Where to find:
Fast Charge Voltage	The SC300 will charge the batteries at up to this voltage until the end of fast charge.	
Boost	If this is enabled, the SC300 will set rectifiers elevated charge voltage until the Fast Charge Voltage is reached. This provides for a slightly faster recharge.	
Voltage Threshold	If the bus voltage drops below this value during an ac supply failure, then <i>Fast Charge</i> starts when the ac supply is restored. Fast charge can also be started based on the <i>Start Ah Threshold</i> .	SC300: Control Processes > Fast Charge DCTools/Web: Control Processes > Fast Charge
Start Ampere Hours Threshold	If <i>Ah Discharged</i> exceeds this value during an ac supply failure, then <i>Fast Charge</i> starts when the ac supply is restored. The threshold is given as a percentage of installed C10 battery capacity. <i>Fast charge</i> can also be started based on the <i>Voltage Threshold</i> .	
Recharge Percentage (%)	The ratio of ampere-hours recharged to the ampere-hours discharged. <i>Fast Charge</i> stops	

either when the Ah recharged equals the Ah discharged x *Recharge Percentage*, or after *Maximum Duration*. *Recharge Percentage* only applies if *Stop Ah Threshold* is set to zero.

Maximum Duration	Set <i>Maximum Duration</i> so that the battery will fully charge but not overcharge.	
Stop Ah Threshold	This value is set so that <i>Fast Charge</i> will stop before the battery is fully charged. This is used when <i>Fast Charge</i> is used to control a generator and the generator should be stopped before the battery is fully charged (thereby saving fuel). <i>Stop Ah Threshold</i> is the discharge percentage at which the charging stops, e.g. 10% means that <i>Fast Charge</i> will stop when the battery is 90% charged. If <i>Fast Charge</i> is not used to control a generator then this value should be set to zero.	
Battery Capacity	The rated 10 hour capacity of the installed battery strings. Zero means no battery is installed.	SC300: Battery > Battery > Battery Capacity DCTools/Web: Batteries

- ☐ *Fast Charge* may also be used to trigger the Generator Control Output. See details on page 75.
- ☐ To avoid excessive fuel use or shortened battery life, it is important that the settings are correct in a hybrid generator/battery power system (cyclic charge/discharge).
 - *Voltage Threshold* should be set so that when a fully charged battery is discharged, the *Start Ah Threshold* is reached before the *Voltage Threshold*.
 - *Maximum Duration* should be set so that in a typical recharge, *Ah Discharged* reaches zero before *Maximum Duration* is reached.
 - Master Configuration files will typically meet these requirements, but the values must be checked against battery discharge/recharge curves in the cyclic application.
- ☐ So that an incorrect *Ah Discharged* value does not affect cyclic battery charging in a hybrid generator/battery power system, an incorrect *Ah Discharged* value will be corrected with one of these adjustments:
 - *Ah Discharged* is set to zero when the recharge reaches *Maximum Duration* (and the battery is assumed to be fully charged).
 - *Ah Discharged* is set to the *Start Ah Threshold* when the battery discharges down to the *Voltage Threshold*.
 - *Ah Discharged* is limited to a maximum value of Battery Capacity.
 - *Ah Discharged* can be set to zero after a Fast Charge or Equalize cycle. See *Batteries Configuration* on page 66.
 - *Ah Discharged* can be automatically counted down when the system is in Float state. See *Batteries Configuration* on page 66.
 - *Ah Discharged* can be manually reset to zero.

Temperature Compensation

As the ambient temperature of a battery drops (or rises) the voltage required to maintain full charge increases (or decreases). Temperature Compensation automatically varies the float voltage to cancel the effects of changing temperature.

Enable Temperature Compensation for optimum battery life and battery capacity over a wider temperature range.

 *Temperature Compensation does NOT function during a Battery Test.*

► **To enable Temperature Compensation**

- Use the SC300 keypad to go to: *Control Processes > Temp. Compensation > Enable.*
- Or, in DCTools/Web go to: *Control Processes > Temperature Compensation.*

Information

The following information is available about Temperature Compensation.

Parameter	Description	Where to find:
State	Indicates if Temperature Compensation is active or inactive.	SC300: Control Processes > Temp. Compensation > Enable
Voltage Offset	The adjustment to the bus voltage being applied due to the Temperature Compensation. Offset is zero when the battery temperature equals the reference temperature.	DCTools/Web: Control Processes > Temperature Compensation
Battery Temperature	The temperature measured by the battery temperature sensor.	SC300: Analogs > Battery Temperature DCTools/Web: Batteries

Configuration

Set the following parameters.

Parameter	Description	Where to find:
Cells Per String	The number of 2V cells per battery string (for example: 24 in a 48V nominal system).	SC300: Battery > Battery Web: Batteries
Slope	Bus voltage adjustment rate. Use the value recommended by the battery manufacturer.	SC300: Control Processes > Temp. Compensation > Enable
Reference Temp	The temperature where no voltage adjustment is applied. Refer also to Float Voltage on page 28.	DCTools/Web: Control Processes > Temperature Compensation
Upper Limit	No additional voltage adjustment is made above this temperature.	
Lower Limit	No additional voltage adjustment is made below this temperature.	

 *If Low Float Tracking is enabled, the **Low Float** alarm threshold will be decreased by the same amount as the temperature compensation offset. This occurs only when temperature compensation decreases bus voltage. There is no effect when temperature compensation increases bus voltage.*

 *If High Float Tracking is enabled, the **High Float** alarm threshold will be increased by the same amount as the temperature compensation offset. This occurs only when temperature compensation increases bus voltage. There is no effect when temperature compensation decreases bus voltage.*

Peak Load Reduction (PLR)

PLR provides a means for a telecom network operator to reduce power consumption at certain times by running on battery rather than AC power. An operator may run on batteries during periods of high AC power grid loading, and receive direct payments from AC grid operators, or reduced power charges. The SC300 is compatible with demand response programmes, either manually controlled, or automatically controlled.

While PLR is active, the SC300 turns down the rectifier voltage to just below the DC bus voltage. The batteries will discharge into the load, while the rectifiers provide a backup if the battery fails. PLR may be set to ensure that the battery voltage does not drop below a preset voltage, the Low Voltage Limit. This ensures the battery is not discharged so low that its life is significantly reduced. If the Low Voltage Limit is reached, the SC300 maintains the bus voltage at that value by holding the rectifier voltage so that it progressively takes more load as the battery discharges. There is also an option to start a generator to recharge the battery once the Low Voltage Limit is reached.

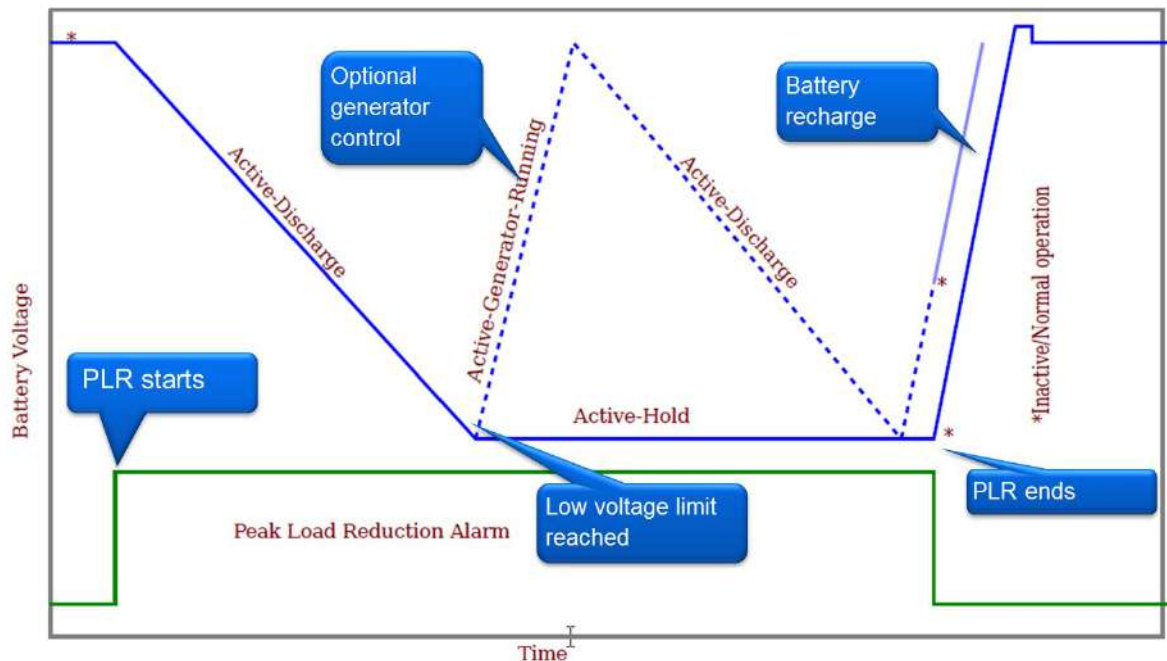

PLR may be triggered manually from the SC300 web interface, automatically from a Smart Alarm, or remotely from EDREM or a similar application.

► To enable PLR

- Use the SC300 keypad to go to: *Control Processes > Peak Load Reduction*.
- Or, in DCTools/Web go to: *Control Processes > Peak Load Reduction*
- Set *Enable* to *Enabled*.
- Set *Maximum Duration* and *Low Voltage Limit* as required.

► To manually trigger PLR

- Use the SC300 keypad to go to: *Control Processes > Peak Load Reduction*.
- Or, in DCTools/Web go to: *Control Processes > Peak Load Reduction*
- Set *Scheduled Start Time* and *Scheduled Duration* as required.

► To use a Smart Alarm to activate Peak Load Reduction (optional)

- In DCTools/Web go to: *Alarms > Smart Alarms*
- Configure a Smart Alarm with the appropriate trigger conditions for PLR. Note the Smart Alarm number.
- Go to: *Control Processes > Peak Load Reduction*
- Set *Activating Smart Alarm* to the appropriate Smart Alarm number.

Information

The following information is available about Peak Load Reduction.

Parameter	Description	Where to find:
State	Indicates if PLR is inactive, active, unable to start, or held at minimum bus voltage	
Time Running	The time that PLR has been running.	
Scheduled Start Time	The start time for PLR. <input type="checkbox"/> <i>Time shown on SC300 is UTC. Time on PC running DCTools/Web is local time. See SC300 Internal Clock on page 17.</i> <input type="checkbox"/> <i>Scheduled Start Time and Duration may be manually set, or set by a remote application such as EDREM.</i>	SC300: Control Processes > Peak Load Reduction Web: Control Processes > Peak Load Reduction
Scheduled Duration	The time that PLR will remain active.	
Offset Voltage	The adjustment to the bus voltage being applied due to PLR. While PLR is running, the rectifiers are turned down to force the battery to carry the load.	

Configuration

Set the following parameters.

Parameter	Description	Where to find:
Enable	Enables or Disables PLR.	
Scheduled Start Time	The start time for PLR. <input type="checkbox"/> <i>Time shown on SC300 is UTC. Time on PC running DCTools/Web is local time. See SC300 Internal Clock on page 17.</i> <input type="checkbox"/> <i>Scheduled Start Time and Duration may be manually set, or set by a remote application such as EDREM.</i>	SC300: Control Processes > Battery Test Web: Control Processes > Battery Test
Scheduled Duration	The time that PLR will remain active.	
Activating Smart Alarm	The number of the Smart Alarm that triggers PLR. "0" means no Smart Alarm trigger. <input type="checkbox"/> <i>The web view will also show the name of the Activating Smart Alarm.</i>	

Solar Charger Power Share

Where a DC power system has energy inputs both from AC mains supply (or AC generator) and solar panels, then the SC300 must share the load power between these sources.

Generally, the preference is for the load to be supplied from the alternative energy source first, and take energy from AC only when there is not enough solar or wind energy.

This is done by increasing the solar charger rectifier voltage slightly. The AC powered rectifiers remain set at the normal float voltage.

Solar charger power share automatically operates when an ASC48-ES solar charger is present.

- If a third-party solar charge controller is used, this should be set at a higher voltage than the float voltage to ensure that it supplies energy in preference to the AC rectifiers.*
- The SC300 AVC function controls the overall charge voltage so that the bus is set to the correct*

voltage setting, even with solar charger offset included.

► **To set the Solar Charger Power Share Offset**

- Use the SC300 keypad to go to: *Rectifiers > Settings*.
- Or, in DCTools/Web go to: *Rectifiers > Configuration*.
- The recommended value is 0.5V to 1.0V.

Configuration

Set the following parameters.

Parameter	Description	Where to find:
Solar Charger Power Share Offset	The solar charger base voltage is increased by this amount relative to the AC rectifier base voltage.	SC300: Rectifiers > Settings DCTools/Web: Rectifiers > Configuration

Rectifiers

The SC300 registers all rectifier modules and solar chargers as they are inserted into the dc power system.

Information

The following information is available about rectifiers:

Parameter	Description	Where to find:
Registered rectifiers	Number of rectifiers controlled by the SC300 <i>Web only</i>	
Registered Solar	Number of solar chargers controlled by the SC300	
Failed	Number of failed rectifiers or solar chargers <i>Web only</i>	SC300: Rectifiers
Comms Lost	Number of failed rectifiers that have lost communications <i>Web only</i>	DCTools/Web: Rectifiers
Solar Comms Lost	Number of failed solar chargers that have lost communications <i>Web only</i>	
State	Registered - communicating with the SC300. Un-registered - there is a rectifier compatibility or communications problem.	
Serial Number (S/N)	Rectifier serial number.	
Load Based Run Time	The time the rectifier has been operating since it was registered. Rectifier run time is recorded to enable balancing of time running by LBRS. It is reset to zero every time the controller starts or a new rectifier is added. It is not a measure of total running time for each rectifier.	SC300: Rectifiers > Enter (Use Left and Right keys to scroll to other rectifiers) DCTools/ Web: Rectifiers
Input Type	AC (rectifiers) or DC (solar chargers)	
Input Voltage	The voltage measured by the rectifier or solar charger.	
Input Current	The input current measured by a rectifier or solar charger. <i>Only available from certain ac rectifiers, e.g. APR48-ES and NPR48-ES.</i>	

AC Frequency	AC frequency as measured by the rectifier. <i>Only available from certain rectifiers, e.g. APR48-ES and NPR48-ES.</i>	
Phase Voltages	The ac phase voltages measured by the rectifiers. This is available from rectifiers that can detect their phase and from three phase rectifiers.	
Phase	The input phase number (1,2 or 3) as measured by certain rectifiers. Phase information is only available if the Phase-1 setting has been set to a rectifier serial number, or a three-phase rectifier is present.	
Voltage	Rectifier's dc output voltage.	
Current	Rectifier's output current.	
Output Power	The output power from the rectifier	
Power (%)	Rectifier output power as a percentage of Max. Power Limit.	
Heatsink Temp	The measured rectifier heatsink temperature.	
Max Power (Limit)	Rectifier's maximum output power (factory set).	
Max Current Limit	The maximum current limit value of the rectifier.  <i>Adjust Rectifier Current Limit to set a lower operating current limit.</i>	
Min OVSD Set Point	The minimum Over Voltage Shut Down set point that the rectifier accepts.	
Max OVSD Set Point	The maximum Over Voltage Shut Down set point that the rectifier accepts.	
Notes	Temporary notes about a rectifier. This is not saved after the rectifier is removed.	
Status	Information about rectifier alarms.	
Type	Rectifier manufacturer's model number.	SC300: Rectifiers > Enter (Use Left and Right keys to scroll to other rectifiers) <i>For DCTools/Web, go to Configuration > RXP to see rectifier software version.</i>
Software Version	Version of rectifier embedded software.	

Common Rectifier Configuration

The following parameters (common to all rectifiers) can be configured.

Parameter	Description	Where to find:
Phase-1	The serial number of the rectifier assigned as "Phase 1". When this is set correctly, it enables the SC300 to assign a phase number to all rectifiers. <i>Only applies to rectifiers that support phase detection, including APR48-ES and NPR48-ES.</i>	
Shutdown All Rectifiers Smart Alarm	The SC300 can shut down all rectifiers under control of this Smart Alarm number. Shutdown must be set to Manual for this to work. Zero means no Smart Alarm shutdown.	
Shutdown All Solar Chargers Smart Alarm	The SC300 can shut down all solar chargers under control of this Smart Alarm number. Shutdown must be set to Manual for this to work. Zero means no	

Parameter	Description	Where to find:
	Smart Alarm shutdown.	
Shutdown	Enable rectifier shutdown. This can be disabled, Manual, or Automatic. Automatic means that LBRS is active.	
OVSD Set Point	Over Voltage Shut Down. A rectifier will shut down if its output voltage exceeds this value. Recommended value is 59.2V for 48V nominal systems, 33.5V for 24V nominal systems.	
Start Up Delay	The delay from ac turn-on before the rectifier output turns on.	
Output Ramp-up slope	The rate the rectifier output voltage increases after start-up as a percentage of maximum current.	
Rect. Current Limit	(DC) The output current limit of each rectifier. If set to zero, then the output current limit is maximum.	SC300: Rectifiers > Rect. Settings
Solar Current Limit	The output current limit of each solar charger. If set to zero, then the output current limit is maximum.	Web/DCTools: Rectifiers
AC System Current Limit	The total AC system current limit. <i>When this is non-zero, each rectifier AC Current Limit is automatically set as follows:</i> $\text{Rectifier AC current limit} = (\text{AC System Current Limit}) / (\text{Number of non-faulty registered rectifiers})$	
AC Rectifier Current Limit	The input AC current limit of the rectifier. If set to zero, then the input current limit is maximum.	
Rectifier Current Share	Current Share ensures that the total output power of the power system is evenly shared between all rectifiers. Set to <i>Enabled</i> unless there is a specific reason to disable.	
Power Share Offset	The solar charger base voltage is increased by this amount to ensure that the solar charger provides maximum power when connected in parallel with AC rectifiers.	DCTools/Web: Rectifiers

 See Voltage Control on page 27 for details of the rectifier's output voltage control.

Phase Detection

In a three-phase system where all rectifiers support phase detection (including APR48-ES and NPR48-ES), the SC300 can automatically detect the AC phase for each rectifier.

 Phases are calculated relative to a particular rectifier.

► To enable Phase Detection

On the Web, go to *Rectifiers*.

Set Phase-1 to the serial number of any rectifier that is on AC Phase 1.

 After one minute or less, the SC300 will assign phases to all rectifiers.

 Phase detection does not work if there are rectifiers that do not support phase detection.



 Leave Phase-1 at 0 for a single-phase system.

Identify a Rectifier

The rectifier's registration number does not correspond to a physical position in the dc power system.

► To identify a rectifier

Either:

- On SC300 keypad go to: *Rectifiers > Rectifier number*. Press *Enter*.
 The rectifier details screen appears. Use   to scroll to other rectifiers.
- All LEDs on the selected rectifier will flash for 60 seconds, or press *Esc* to stop.

Or:

- In DCTools/Web go to: *System > Interfaces > RXP > RXP Devices*.
- All LEDs on the selected rectifier will flash for 60 seconds.
 Rectifier serial numbers are printed on a label on the front of each rectifier.

Rectifier Comms Lost Alarm

When a rectifier is removed (or a fault interrupts rectifier communications), the SC300 will display an alert message and sound an alert alarm (if *Audible Alarms* are enabled). After the *Alarm Recognition Period*, a *Rectifier Comms Lost* alarm will activate.

- A Multiple Rectifier Comms Lost alarm will activate (after the Alarm Recognition Period) if more than one rectifier is affected.*

► To prevent a *Rectifier Comms Lost* alarm when a rectifier is removed

Press any key within the *Alarm Recognition Period*, to cancel the alert.

Solar Comms Lost Alarm

When a solar charger is removed (or a fault interrupts communications), the SC300 will display an alert message and sound an alert alarm (if *Audible Alarms* are enabled). After the *Alarm Recognition Period*, a *Solar Comms Lost* alarm will activate.

- A Multiple Solar Comms Lost alarm will activate (after the Alarm Recognition Period) if more than one solar charger is affected.*

► To prevent a *Solar Comms Lost* alarm when a solar charger is removed

Press any key within the *Alarm Recognition Period*, to cancel the alert.

Rectifier / Solar charger Shutdown

Rectifier / solar charger shutdown can be disabled, controlled manually, or controlled automatically based on the total rectifier load current (see Load Based Rectifier Shutdown on page 43).

► To disable Rectifier / solar Shutdown

- Use the SC300 keypad to go to: *Rectifiers > Settings (tab) > set Rectifier Shutdown to Disabled*.
- Or, in DCTools/Web go to: *Rectifiers > Configuration > set Shutdown to Disabled*.

Manual Rectifier / Solar Shutdown

► To shut down a rectifier / solar charger

- In DCTools/Web go to: *Rectifiers > Configuration*.
- Set *Shutdown* to *Manual*.
- In the *Rectifiers* table click *Shutdown*. *This box only appears when Shutdown is set to Manual*.
- The rectifier will shut down and the yellow LED will be on.
 - ☐ *This function will normally only be used for testing purposes. When the testing is complete, set Shutdown back to its previous setting (Disabled or Automatic).*

Rectifier Restart

► To restart all shutdown rectifiers / solar chargers

- Use the SC300 keypad to go to: *Rectifiers > Rect. Settings (tab) > Restart All Rectifiers*.
- Or, in DCTools/Web go to: *Rectifiers*. Click *Restart All*.

► To restart individual rectifiers / solar chargers

- In DCTools/Web go to: *Rectifiers*.
- For each rectifier / solar charger click *Startup*.

The rectifier(s) will then resume normal operation.

- ☐ *The SC300 will restart any shutdown rectifiers / solar chargers if:
ac has failed, or more than one rectifier has failed, or the bus voltage is below the Low Load threshold, or Shutdown is set to Disabled, or Shutdown is set to Automatic.*

Load Based Rectifier Shutdown

	<p>Redundancy = N</p> <p>If redundancy is set to N and no batteries are connected, plus the alternative energy source is not producing enough power, then there is a risk of the system load being dropped. Do not set <i>Redundancy</i> to N at mission-critical sites.</p>
	<p>Supported Rectifiers</p> <p>Load Based Rectifier Shutdown is not compatible with APR48-3G (prior to PR5), EPR48-3G, APR24-3G and CR48-3G rectifiers. Using it with any of these rectifiers may lead to premature rectifier failure.</p>

-  *Rectifier run time is recorded to enable balancing of time running by LBRS. It is reset to zero every time the controller starts or a new rectifier is added. It is **not** a measure of total running time for each rectifier.*

If Load Based Rectifier Shutdown (LBRS) is enabled by setting *Shutdown* to *Automatic* then the SC300 automatically shuts down rectifiers when the total load current is significantly less than the total rectifier capacity.

This raises the average load on the remaining rectifiers which will then operate at a higher efficiency. This results in a decrease in system power consumption.

The SC300 shuts down APR48-3G PR5 rectifiers before the more efficient APR48-ES and NPR48-ES rectifiers.

The run time of all rectifiers is recorded and the usage within each group of rectifiers is balanced to ensure even aging.

The SC300 will progressively restart rectifiers if the load increases.

The number of rectifiers left running by LBRS depends on the *Redundancy* setting:

- N Plus 2: Two spare rectifiers are always running. Three or more rectifiers are always running.
- N Plus 1: One spare rectifier is always running. Two or more rectifiers are always running.
- N: If an alternative energy source is powering the load, then all rectifiers can be shut down. Otherwise at least one rectifier is always running. There is no redundant rectifier.

-  *Rectifiers shut down by LBRS will have the yellow LED on.*

-  *The SC300 will automatically restart all rectifiers if ac supply has failed, or more than one rectifier has failed, or Battery Test / Equalize / Fast Charge are active, or the bus voltage is below the Low Load threshold.*

-  *In a three-phase system with phase detection, LBRS will shut down rectifiers in such a way as to keep a similar number of rectifiers on each phase.*

-  *LBRS is not applied to solar chargers.*

► **To enable Load Based Rectifier Shutdown**

- Use the SC300 keypad to go to: *Rectifiers > Settings (tab) > set Rectifier Shutdown to Automatic.*
- Or, in DCTools/Web go to: *Rectifiers > Configuration* and set *Shutdown* to *Automatic*.

-  *Ensure that Rectifier Start Up Delay is less than 30 seconds. See information on page 40. LBRS will not function correctly if the start-up delay is more than 30 seconds.*

Information

The following information is available about Load Based Rectifier Shutdown.

Parameter	Description	Where to find:
Load Based Run Time	The run time of each rectifier	DCTools/Web: Rectifiers
System Power	The percentage of maximum output power that the system is providing. This is used by LBRS to calculate whether to shut down or start up rectifiers	DCTools/Web: Rectifiers > Load Based Rectifier Shutdown

Configuration

The following parameters must be configured to set Load Based Rectifier Shutdown.

Parameter	Description	Where to find:
Shutdown	Set to Automatic to enable LBRS	SC300: Rectifiers > Configuration DCTools/Web: Rectifiers > Configuration
Redundancy	The number of spare rectifiers kept running: N Plus 2: Two spare rectifiers are always running. Three or more rectifiers are always running. N Plus 1: One spare rectifier is always running. Two or more rectifiers are always running. N: If an alternative energy source is powering the load, then all rectifiers can be shut down. Otherwise at least one rectifier is always running. There is no redundant rectifier.	SC300: Rectifiers > Settings (tab) > LBRS DCTools/Web: Rectifiers > Load Based Rectifier Shutdown
High Threshold	LBRS restarts one or more rectifiers if the load is more than this percentage of the total rectifier capacity. Typical: 60%.	
Low Threshold	LBRS shuts down one or more rectifiers if the load is less than this percentage of the total rectifier capacity. Typical: 40%. Shutdown does not occur if shutting down a rectifier would push load percentage above <i>High Threshold</i> .	
Interval	The time interval that the SC300 will cycle rectifiers when the LBRS process is active.	
Reset Run Times	Sets the run time of all rectifiers to zero.	

Low Voltage Disconnect (LVD)

Low Voltage Disconnects may be connected either as load disconnect or battery disconnect depending on the dc power system model. They have two purposes:

- to protect a VRLA battery from deep discharge and premature failure, and/or
- to reduce the load on a battery under discharge so that high priority equipment operates for a longer time after an ac supply failure.

The SC300 has 16 independent LVD control channels (LVD 1 to LVD 16). Each channel can control one or more of up to 16 contactors, with coil voltages from 12V to 48V nominal.

- ☐ There are two contactor connectors on an IOBGP-00/01 Input / Output board, and three on the IOBGP-10/11. Additional contactors are controlled by additional IOBGP-01 Input / Output boards. If required, refer to the dc power system Installation and Operation Guide for details on how to connect additional IOBGP Input / Output boards to the SC300.

Latched contactors

The IOBGP-10/11/20/21 IO Boards support latched contactors. Latched contactor operation is managed by the IOBGP and does not affect SC300 operation or settings.

Use **Normally Open** settings for latched contactors.

LVD Disconnect Modes

The LVD control channels can have any combination of the following modes of operation:

- 1 Voltage Based Disconnect:** The LVD control channel will disconnect its contactor(s) based on the bus voltage.
- 2 AC Timer Based Disconnect:** The LVD control channel will disconnect its contactor(s) after a specified period of ac supply failure.
- 3 Smart Alarm Disconnect:** The LVD control channel will disconnect its contactor(s) according to the state of a specified *Smart Alarm*. See *Smart Alarm Disconnect* on page 51.

If *Chained to Previous* is enabled, the LVD control channel will only disconnect its contactor(s) if one of its disconnect conditions is *True*, and the preceding control channel has been disconnected for the *Recognition Time*.

- ☐ *Chained to Previous* does not apply to LVD 1.

LVD Default and Custom Configuration

If factory-fitted in the dc power system, the LVD contactors will be characterized and the LVD control channels will have default configuration settings for *Voltage Based Disconnect*.

Custom configuration will only be necessary if:

- contactors are connected to the dc power system on site (see LVD Characterization on page 47 and LVD Setup on page 49)
- different disconnect conditions are required (see LVD Configuration on page 50).

Typical LVD Arrangements

The simplest use of an LVD is a single battery disconnect contactor.

The following diagram shows a typical arrangement of two LVDs. This arrangement allows lower priority loads to be disconnected first (contactor controlled by control channel LVD 1), either at a specified battery voltage or a specified time interval after an ac supply failure. This then prolongs battery power for the highest priority loads (contactor controlled by control channel LVD 2). The battery will be disconnected when the battery voltage reaches its minimum preset voltage.

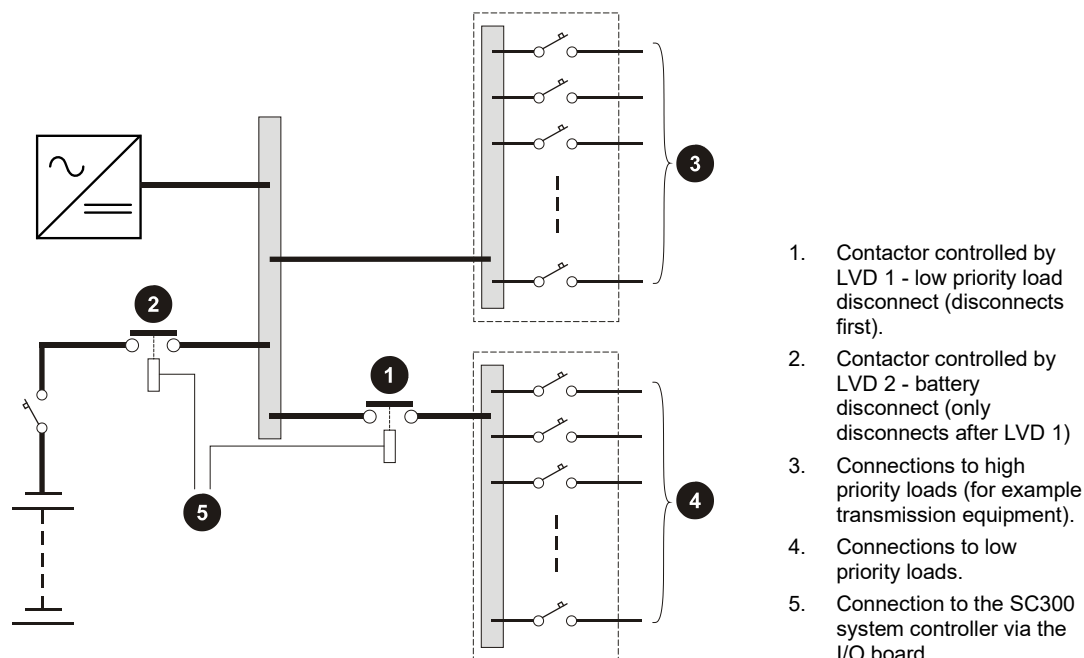

More complex arrangements with up to 16 contactors and a selection of disconnection criteria are possible with the SC300 system controller. The exact arrangement(s) used in a particular Eaton dc power system will be described in the Installation and Operation Guide.

Characterization

The LVD Characterization process determines the optimum operating voltages to suit the contactor(s) coil voltage. These values are stored in the SC300 and on the I/O board.

An *LVD Characterization Error* alarm will be activated if the SC300 detects that the characterization values stored in the SC300 and on the I/O board are different. This happens when any of these occurs:

- The SC300 is replaced.
- The I/O Board is replaced.
- Both the SC300 and the I/O Board are replaced.

LVD Characterization Error alarms can only be cleared from the SC300 front panel, not using Web.

- To clear the alarm when the SC300 is replaced, on the SC300 go to *Alarms*, select the *LVD Character. Err.* active alarm and press *Details*, select *Clear* and press *Enter*, select *Characterize with IOB Values* and press *Save*.
- To clear the alarm when the I/O Board is replaced, on the SC300 go to *Alarms*, select the *LVD Character. Err.* active alarm and press *Details*, select *Clear* and press *Enter*, select *Characterize with SC Values* and press *Save*.
- To clear the alarm when both the SC300 and the I/O Board are replaced, go to *Alarms*, select the *LVD Character. Err.* active alarm and press *Details*, select *Clear* and press *Enter*, select *Characterize Contactor* and press *Start*.

 When a contactor is re-characterized it will disconnect and re-connect several times. Refer to *Maintenance in the dc power system Installation and Operation Guide* for full instructions.

Factory-fitted contactors will be characterized at the factory. If an existing contactor is replaced, characterize the new contactor from the SC300.

 In this case, there will be no *LVD Characterization Error* alarm.

- To characterize the new contactor, go to *Battery*, go to the *LVDs* tab, select the appropriate LVD channel and press *Details*, select the appropriate contactor and press *Edit*, select *Characterization* and press *Enter*, select *Characterize Contactor* and press *Start*.

LVD Operation

▶ To allow access to LVD functions from the SC300 keypad

- In DCTools/Web go to: *Control Processes > LVD*.
- Select the *Allow Front Panel LVD Control* check box.

If the check box is cleared LVD functions can only be accessed using DCTools/Web.

▶ To manually connect or disconnect an LVD control channel from the front panel

- Use the SC300 keypad to go to: *Battery > LVDs > LVD 1 - LVD 16 > Details > Manual Control*.
- Select *Connect or Disconnect* to connect or disconnect the channel (and all mapped contactors).

The contactor(s) will remain in the selected state until the manual reconnect timeout period is reached or the contactor is manually reconnected.

- Select *Auto* to return the LVD control channel to automatic operation.

▶ To manually disconnect an LVD control channel using web

- Go to *Low Voltage Disconnect > LVD Manual Control*
- Select *Disconnect* to disconnect the channel (and all mapped contactors).

The contactor(s) will remain in the selected state until the manual reconnect timeout period is reached or the contactor is manually reconnected.

▶ To manually disconnect an LVD control channel using DCTools

- Go to *Control Processes LVD > Logical LVDs*
- Click on *Remote Manual Control* for the contactor to be disconnected and select *Apply Changes*.

The contactor(s) will remain in the selected state until the manual reconnect timeout period is reached, or the contactor is manually reconnected.

Information

The following information is available about LVD control channels and contactors.

Parameter	Description	Where to find:
LVD Control Channel State	<p>Connected: all the channel's disconnect conditions are false. All mapped contactors are connected (contacts closed).</p> <p>Disconnected: one of the channel's disconnect conditions is true. All mapped contactors are disconnected (contacts open).</p> <p>Manual: The LVD is under manual control from the SC300 keypad (see previous section).</p> <p>No Contactors: there are no contactors mapped to this channel.</p> <p>Idle: The LVD has not yet connected or disconnected.</p>	<p>SC300: <i>Battery > LVDs</i></p> <p>DCTools/Web: <i>Control Processes > LVD</i></p>
LVD Control Channel Inhibited	Indicates if the LVD cannot change state due to the <i>Inhibit Period</i> .	
Contactor State	Disabled: contactor cannot be operated	

Connected: contactor is connected (contacts closed)

Disconnected: contactor is disconnected (contacts open)

Failed: contactor is not connected to the I/O board or is faulty.

Conflict: two contactors are mapped to the same I/O board connector.

Not Characterized: the contactor must be characterized (see details on page 47).

LVD Remote Manual Reconnect Timer	If the LVD has been manually disconnected, this will count down from the LVD Remote Manual Reconnect Timeout Period until it reconnects at zero.
-----------------------------------	--

LVD Setup

Use the following procedures to enable or add an LVD control channel.

► To Enable (Add) an LVD using the SC300 keypad

 Control and configuration of LVDs and contactors is only available from the SC300 keypad if Allow Front Panel LVD Control is TRUE. See LVD Operation on page 48.

- 1 Go to: *Battery* > *LVDs*.
 - 2 If there are no LVDs (LVD 1, LVD 2, ...) listed then go to Step 4.
 - 3 For each LVD select *Details*. Note the contactors operated by each channel.

 The contactor numbers (1-1, 1-2, ...) indicate the existing IOB Number - IOB Connector Number combinations.
 - 4 Go to: *Battery* > *LVDs* > *Add LVD*.
 - 5 From the list of registered I/O boards, select a board connected to a contactor to be operated by this LVD control channel. Select *Next*.
 - 6 For IOBGP I/O boards (see Input /Output Board on page 2) select:
 - 1, if the contactor is connected to XH4
 - 2, if the contactor is connected to XH5.
- Warning:** Do not select an existing IOB Number - IOB Connector Number combination (see Step 3). This will cause a conflict.
- 7 Select *Next*.
 - 8 Select contactor type:
 - *Normally Open* if contacts are open when coil voltage is zero, or a latched contactor is used.
 - *Normally Closed* if contacts are closed when coil voltage is zero.
 - 9 Characterize the contactor (see LVD Characterization on page 47).
 - 10 To add additional contactors to the LVD control channel, go to *Battery* > *LVDs* > *LVD x* > *Add Contactor*. Repeat Steps 5-9.

► To Enable an LVD using Web / DCTools

- 1 In Web go to: *Control Processes* > *LVD*. Expand the *Logical LVDs* table.
- 2 Select a spare LVD control channel and configure as required. See LVD Configuration on page 50.
- 3 Expand the *Physical Contactors* table.
- 4 Select and configure the contactor(s) to be operated by the LVD control channel. See Contactor Configuration on page 51.

General Configuration Settings

Parameter	Description	Where to find:
Inhibit Period	The minimum time an LVD stays connected or disconnected before it can change state. Does not apply to manual operation.	SC300: Battery > LVDs DCTools/Web: Control Processes > LVD
Allow Front Panel LVD Control	Disables LVD control from the system controller front panel.	DCTools/Web: Control Processes > LVD
LVD Remote Manual Reconnect Timeout Period	If an LVD is manually disconnected, it will reconnect again after this time.	Web: Control Processes > LVD <i>Not available on DCTools</i>

LVD Configuration

Parameter	Description	Where to find:
Voltage Based Disconnect	If <i>Enabled</i> , the LVD will disconnect if the bus voltage has been below the <i>Disconnect Voltage</i> for the <i>Recognition Time</i> and reconnect if the bus voltage has been above the <i>Reconnect Voltage</i> for the <i>Recognition Time</i> .	
Disconnect Voltage	See <i>Voltage Based Disconnect</i> .	
Reconnect Voltage*	See <i>Voltage Based Disconnect</i> .	
Recognition Time	See <i>Voltage Based Disconnect</i> and <i>Chained To Previous</i> .	
AC Timer Based Disconnect	If <i>Enabled</i> , then during an ac supply failure the LVD will disconnect after the <i>AC Timer Delay</i> , even if the <i>Disconnect Voltage</i> has not been reached.	SC300: Battery > LVDs > LVD x > Settings
AC Timer Delay	See <i>AC Timer Based Disconnect</i> .	Web: Control Processes > LVD > LVDs
Smart Alarm Based Disconnect	If <i>Enabled</i> , the LVD will disconnect when the <i>Smart Alarm</i> specified by <i>Smart Alarm Index</i> becomes active. <i>See Smart Alarm Disconnect on page 51.</i>	
Smart Alarm Index	See <i>Smart Alarm Based Disconnect</i> .	
Chained To Previous (Chaining)	If <i>Enabled</i> , the LVD channel will only disconnect if one of its disconnect conditions is true and the preceding LVD channel has been disconnected for the <i>Recognition Time</i> . This applies in reverse when reconnecting. <i>Does not apply to LVD 1.</i>	

☐ * If the LVD channel operates contactors used as a load-disconnect, ensure the Reconnect Voltage is set higher than the expected open-circuit recovery voltage of the discharged batteries.

Contactors Configuration

Parameter	Description	Where to find:
LVD Num	Set to the number of the LVD control channel that will operate this contactor. <i>In Web, number is from first column of the Logical LVDs table.</i>	SC300: See LVD Setup on page 49.
Enable	Set to <i>Enabled</i> for this contactor to be operated (connected and disconnected). <i>If a connected contactor (contacts closed) is Disabled, it will remain connected unless the coil is disconnected from the I/O board or the I/O board loses power.</i>	DCTools/Web: Control Processes > LVD > Physical Contactors
IOB Number (On IOB)	Set to the number of the I/O board from the <i>I/O Board to Serial Number Mapping</i> table. <i>See I/O Board Mapping on page 139.</i>	
IOB LVD Number (LVD Connector)	For IOBGP I/O boards, set to: 1, if the contactor is connected to XH4 2, if the contactor is connected to XH5. <i>See Input / Output Board on page 2.</i>	SC300: Battery > LVDs > LVD x > Contactors (x-1, x-2, ...) > Edit
Type	Set according to the type of contactor: <i>Normally Open</i> if contacts are open when coil voltage is zero, or for latched contactors, which open or close on current pulses.  <i>Use the Normally Open setting for latched contactors.</i> <i>Normally Closed</i> if contacts are closed when coil voltage is zero. Normally closed LVD contacts require special system wiring when used to disconnect the battery. Connect Eaton for further details.	DCTools/Web: Control Processes > LVD > Physical Contactors

Smart Alarm Disconnect

An LVD control channel can be set to disconnect if a specified *Smart Alarm* becomes active. For example, a battery LVD can be set to disconnect if the battery temperature is too high, or a load LVD can be set to disconnect when *Ah Discharged* exceeds a defined value.



An unwanted LVD disconnect may occur if *Smart Alarm Disconnect* uses a sensor which becomes faulty or disconnected.

An unwanted LVD disconnect may occur if *Battery Time Remaining* is used as a source for Smart Alarm Disconnect.

► To configure a Smart Alarm Disconnect

- 1 On DCTools/web, go to: *Alarms > Smart Alarms*. Configure a *Smart Alarm* as described on page 59.
- 2 Note the *SA Number* (first column of the *Smart Alarm States* table).
- 3 Go to: *Control Processes > LVD*.
- 4 For the required LVD control channel:

- Set *Smart Alarm Index* to the *SA Number* (first column of the *Smart Alarm States* table).
- Set *Smart Alarm based Disconnect* to *Enabled*.

The LVD control channel will disconnect its contactor(s) if the *Smart Alarm* becomes active.

 *Except, if Chained to Previous is enabled then the preceding LVD control channel must be disconnected first.*

Alarms

An SC300 supplied with a standard configuration file (see details on page 25) has a standard set of alarms configured and enabled. This will be sufficient for standard dc power system operation. For specific alarm arrangements all SC300 alarms can be individually enabled or disabled and are configurable.

Types of Alarms

The SC300 provides five types of alarms:



Alarm type	Description	Configuration
System alarms	Generated by the operating values of dc power system (voltages, currents, temperatures, and so on) and the operation of power system modules (rectifiers, circuit breakers, fuses, and so on). The SC300 system alarms are listed in Alarm Descriptions on page 127.	See details on page 54.
Analog Input (AI) High alarms	Activated when the input value of an AI is above the alarm threshold.	See details on page 82.
Analog Input (AI) Low alarms	Activated when the input value of an AI is below the alarm threshold.	See details on page 82.
Digital Input (DI) alarms	Activated when a DI is in its active state.	See details on page 86.
Smart Alarms	Software simulation of logic gates to allow the logical combination of other alarms, time schedules and/or system values.	See details on page 57.















Active Alarm Indications

All alarms have a configured *Severity*:

 Critical  Major  Minor  Warning  Control

The *Severity* determines how an active alarm is indicated:

Severity	Alarm indications	Details
 Critical	SC300 Major alarm LED will turn on.	See details on page 13.
 Major		

 Minor  Warning	SC300 Minor alarm LED will turn on.	See details on page 13.
 Critical  Major  Minor	If the SC300 audible indicator is enabled, it will sound until a key is pressed.	See details on page 13.
	The alarm name and severity icon will be displayed on the SC300 main screen.	See details on page 7.
	The <i>Event Log</i> will record the alarm activation.	See details on page 94.
Any alarm	If configured, an Email message will be sent to one or more Email addresses.	See details on page 108.
 Critical  Major  Minor  Warning	If configured, an SMS text message will be sent to one or more cell phones.	See details on page 112.
	If configured, PowerManagerII software will detect the alarm. PowerManagerII can initiate various actions when it receives an alarm notification.	Refer to the PowerManagerII online Help.
	In DCTools/Web (if connected), the alarm name and severity icon will be displayed in the <i>Alarms</i> list on the <i>System</i> page.	See page 104.
	If configured, an SNMP Trap will be sent to a network management system (NMS).	See details on page 105.
	If configured, a note will be displayed on the SC300 and included in the SNMP trap (if used).	Refer to the alarm's configuration details.
Any alarm or control output	If configured, one or two digital outputs (relays) will be operated.	Refer to the alarm's configuration details.
 Critical  Major  Minor  Warning  Control		

► **To view a list of active alarms**

- Use the SC300 keypad to go to: *Alarms*.
- Or, in DCTools/Web, go to *System*.

Alarm Change Indication

The time and date of the last alarm state change is shown in the web view in *Alarm States, Change* column.





Common Alarm Parameters

The following parameters are shared by several, or all alarms.

Parameter	Description	Where to find:
Enable Audible Alarm Indication	Enable or disable the audible alarm indicator.	
Alarm Recognition Period	<p>All alarms (except those listed below) are activated only after the alarm condition is present for this period.</p> <p><i>These alarms have individual recognition periods: AC Fail, System Overload, Generator Fail.</i></p> <p><i>These alarms do not have recognition periods: Battery Test Fail, Configuration Error, Missing Hardware, Standby Mode, String Fail, Unknown Hardware, Unmapped IOB Found, and all LVD alarms.</i></p>	<p>SC300: Alarms > Alarm Settings > Global Settings</p> <p>DCTools/ Web: Alarms > Alarm Configuration</p>

System Alarm Configuration

The following system alarm parameters can be configured.

Parameter	Description	Where to find:
Severity	<p>Set to the required alarm priority. This determines how the alarm is indicated. See details on page 52.</p> <p>If set to <i>Disabled</i> then the alarm will not activate.</p>	
DO Mapping A	If required, select a digital output (relay) that will be operated when the alarm is active.	
DO Mapping B	If required, select a second digital output (relay) that will be operated when the alarm is active.	SC300: Alarms > Alarm Settings (tab) > System Alarm. Select an alarm.
Send Trap	Depending on this setting, an SNMP Trap will be sent for this alarm, on activation or deactivation or both, if the alarm's Severity matches the setting of the SNMP Trap Level (see details on page 107).	<p>Use   to scroll to other alarms.</p> <p>DCTools/ Web: Alarms > Alarm States</p>
Notes	<p>Type any required description. When the alarm is active the text will be displayed on the web interface, in the Alarms details view of the SC300 and included in the SNMP trap (if used).</p> <p>The notes can provide instructions about what action to take when the alarm occurs.</p>	
Recognition Period	<p>The following alarms have individual recognition periods: AC Fail, System Overload, Generator Fail.</p> <p><i>All other system alarms either use the standard Alarm Recognition Period or do not have a recognition period. See details on page 54.</i></p>	<p>SC300: Alarms > Alarm Settings (tab) > System Alarm. Select an alarm.</p> <p>Use   to scroll to other alarms.</p>
High or Low Threshold	The following alarms have a high or low threshold: High Float, Low Float, High Load, Low Load, Battery Temperature High, Battery Temperature Low.	DCTools/ Web: Alarms > Alarm Configuration

	The alarm will be activated if the measured value is above or below this value, as applicable.	
Enable High Float Tracking	If enabled, the High Float alarm threshold will be increased when the operating voltage is increased by a voltage control process.	
Enable Low Float Tracking	If enabled, the Low Float alarm threshold will be decreased when the operating voltage is decreased by a voltage control process.	
In Discharge Alarm Condition	Set to Always or change to Only when AC present as required.	
Battery Temperature Alarm Thresholds	The thresholds for Battery Temperature High and Low alarms are configured here.	
AC Alarm Thresholds	Used in three phase systems, where the rectifier phase is known. <i>See also Rectifiers p39.</i> AC Phase 1/2/3 Fail and AC Phase 1/2/3 Voltage alarms have % deviation thresholds from the <i>Nominal AC Voltage</i> . For each of these alarms, a common threshold applies for all phases.	SC300: Alarms > Alarm Settings (tab) > System Alarms DCTools/ Web: Alarms > Alarm Configuration > AC Alarm Thresholds
Nominal AC Voltage	Used by the AC Phase 1/2/3 Fail and AC Phase 1/2/3 Voltage alarms.	SC300: Alarms > Alarm Settings (tab) Web: Alarms > Alarm Configuration > AC Alarm Thresholds

The following system alarms have particular configuration settings:

- System Overload / System Overload B alarm. See details on page 56.
- Battery Symmetry monitoring. See details on page 67.

System Alarm Reset

The following system alarms are latched. That means the alarm indication remains active even after the cause is no longer present.

- Rectifier Comms Lost
- Solar Comms Lost
- Standby Mode
- Battery Test Cancelled
- Better Test Failed
- Low Rectifier Capacity

These alarms can be reset as follows:

SC300: Press the up arrow. Select the alarm to reset. Press *Clear*.

Web / DCTools: Go to the bottom of the Alarms Table and press the appropriate button.

Alarm Inhibiting

To prevent a single series of faults triggering multiple alarms, an alarm is inhibited by another active alarm if the conditions that trigger the inhibiting alarm include the conditions that trigger the inhibited alarm. However, the inhibiting alarm only inhibits if it is set to a level of severity that is equal to or higher than the alarm being inhibited.

For example, *Partial AC Fail* is inhibited if *AC Fail* is active and *AC Fail* is set to a level of severity that is equal to or higher than *Partial AC Fail*.

Alarm Descriptions on page 127 lists the inhibiting alarms that can inhibit each alarm.

System Overload Alarms

The System Overload and System Overload B alarms activate if the total system load exceeds a percentage of the installed rectifier capacity for a specified period, or if the total system load exceeds a percentage of the installed rectifier capacity minus the capacity of the largest one or two rectifiers if *System Overload Type* is set to *Redundancy N Plus 1* or *N Plus 2*. This indicates that additional rectifiers need to be installed. This is useful at sites where there is ongoing installation of additional load equipment.

► To enable System Overload

- From DCTools/ Web go to: *Alarms > Alarm States*. Enable and configure *System Overload* (or System Overload B) alarm. See System Alarm Configuration on page 54.
- Go to: *Alarms > Alarm Configuration*. Configure the *System Overload* alarm parameters. See details on page 56.

Information

The following information is available about System Overload.

Parameter	Description	Where to find:
System Power	The output power of the system as a percentage of the total nominal power the system is capable of supplying.	SC300: Analogs DCTools/ Web: Analog Inputs

Configuration

Set the following parameters.

Parameter	Description	Where to find:
System Overload Type	<p>The System Overload alarm can be based on either <i>Total Capacity</i> or <i>Redundancy</i>.</p> <p>If the system overload type is based on <i>Total Capacity</i> then the alarm will trigger when the load is above the <i>System Overload Threshold</i> for the <i>System Overload Recognition Period</i>.</p> <p>If the system overload type is <i>Redundancy N Plus 1</i>, then the alarm will trigger when the load is above the total current capacity of the system minus the current capacity of the largest rectifier, for the <i>System Overload Recognition Period</i>.</p> <p>If the system overload type is <i>Redundancy N Plus 2</i>, then the alarm will trigger when the load is above the total current capacity of the system minus the current capacity of the largest two rectifiers, for the <i>System Overload Recognition Period</i>.</p> <p><i>An alarm will always activate if the system overload type is set to Redundancy N Plus 1, when there is only one rectifier installed, or Redundancy N Plus 2, when there are only two rectifiers installed.</i></p>	DCTools/ Web: Alarms > Alarm Configuration

System Overload Type B	See System Overload Type above.
System Overload Recognition Period	The System Overload alarm activates if the load is above the threshold continuously for this time. It is normally set to several hours so that the alarm does not operate during a normal battery recharge. <i>This setting is common to System Overload and System Overload Type B.</i>
System Overload Threshold	The System Overload alarm activates if System Overload Type is set to Total Capacity and the load is above this threshold continuously for the <i>System Overload Recognition Period</i> . Measured as a percentage of total rectifier capacity.
System Overload Threshold B	See System Overload Threshold above.

Smart Alarms

Smart Alarms are a software simulation of logic gates to allow the logical combination of other alarms, time schedules and/or system values. Up to 32 *Smart Alarms* can be configured.

A single *Smart Alarm* is the equivalent of a multi-input AND, OR or XOR logic gate. More complex logic arrangements are created by using one *Smart Alarm* as an input into another. For example:

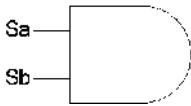
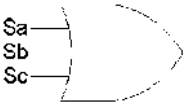
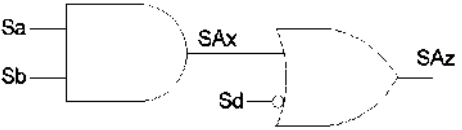
Two input AND gate: $SA_x = SA_a \text{ AND } SA_b$	
Three input OR gate: $SA_y = SA_a \text{ OR } SA_b \text{ OR } SA_c$	
Multi-gate logic: $SA_z = SA_x \text{ OR } \text{NOT } SA_d$ <i>One input is Smart Alarm SAx (output from another gate). The other input is negated. This is available with Alarm Sources only.</i>	

Key:

SA_x, SA_y, SA_z are *Smart Alarms* (entered in the *Smart Alarms* table).

SA, SB, SC, SD are the *Sources* (entered in the *Alarm Sources, Schedule Sources, System Value Sources, or Manual Sources* tables).

Smart Alarms also have optional activation and deactivation delays. When activated they can cause alarm indications (unless *Severity* is set to *Control*) and can activate one or two digital outputs (in the same way as other alarms).

Smart Alarms may also be used to start and stop control functions, including Equalize, Peak Load Reduction, and LVD.

 For more information and application examples contact your Eaton DC product supplier and request the Eaton Application Note for SC300 Smart Alarms.

Sources

The inputs to *Smart Alarms* are called *Sources*.

Sources can be any combination of:

- **Alarm Sources** (up to 64):
System Alarms, Analog Input High alarms, Analog Input Low alarms, Digital Input alarms, Other Smart Alarms
 Alarm Sources can either use the alarm's recognition period, or be triggered immediately. Alarm Sources can also be triggered either when the source alarm becomes active or when it becomes inactive.
- **Time Schedules** (up to 20)
 Time schedules can repeat for a fixed number of times, or indefinitely.
- **System Values** (up to 20):
Bus Voltage, Rectifier Current, Load Current, Battery Current, AC Input Current, DC Input Current, Battery Temperature, Load Power, System Power, Ah Discharged, Number Of Rectifiers Failed, Number Of Rectifiers Comms Lost, Number of Solar Comms Lost, AC Voltage, DC Input Voltage, DC Input Voltage Max, DC Input Voltage Min, Rectifier Input Voltage, Solar Input Voltage, Battery Time Remaining, Battery Health, Alternative Source Current, Solar Current, Solar Power, Generator Current, Highest Rectifier Heatsink Temperature, Fuel Level, Generator Backup Time, Fuel Remaining Time, Smart Analog, Energy Meter, Power Meter, Current Meter, Voltage Meter, Operating Voltage, Fan Temperature, DCDC Voltage, DCDC current, DCDC Power, DCDC Heatsink Temperature.
 System Value Sources are active either when the system value is above or below a defined threshold value.
 Energy Meter, Power Meter, Current Meter, Voltage Meter are the values defined for each meter in the Energy Metering Configuration. For instance, Power Meter 2 is the power associated with Energy Meter 2. Current Meter 2 is the current used to calculate power and energy for Energy Meter 2. It will be invalid if Energy Meter 2 power is read directly from a solar charger.
- **Manual Sources** (up to 20):
These allow a user to activate or deactivate a Smart Alarm from a button on the web interface. A manual source may also be set to activate at a preset period.

Smart Alarm Source options

The following parameters affect the operation of Smart Alarm alarm / system value sources:

Parameter	Description	Notes
Trigger Type		
Level	The Smart Alarm is active when the source is active	
Edge Set	The Smart Alarm will become active when the source becomes active, and will remain active even if the source becomes inactive.	Use Edge Set and Reset to give a latching function, as per a Set-Reset flip-flop.
Edge Reset	The Smart Alarm will become inactive when the source becomes active, and will remain inactive even if the source becomes active.	
Active Count	Sets the number of transitions before the Smart Alarm becomes active. E.g. If this is set to 2, then two inactive to active transitions are required before the Smart Alarm becomes active.	For example, set Active Count and Inactive count both to 2. This gives a divide by 2 counter.
Inactive Count	Sets the number of transitions before the Smart	

Alarm becomes inactive. E.g. If this is set to 2, then two active to inactive transitions are required before the Smart Alarm becomes inactive.

Smart Alarm Actions

This section provides a means to view and configure control function actions triggered by Smart Alarms.

 Not all Smart Alarm control is configured in this section. LVD control is configured in the LVD section.



Smart Alarms may be configured to:

- Trigger an LVD disconnect
- Trigger an equalize cycle
- Trigger Peak Load Reduction (PLR)
- Shut down all rectifiers
- Shut down all solar chargers
- Change the rate of data logging.
- Change voltage control to use *Alternative Float Voltage* rather than *Float Voltage*.

Configuration

Information

The following information is available about *Smart Alarms* and *Sources*.

Parameter	Description	Where to find:
Smart Alarm State	The present state of the <i>Smart Alarm</i> . If <i>Enabled</i> and active, this will be the alarm's <i>Severity</i> . If <i>Disabled</i> , or <i>Enabled</i> but inactive, the state is shown as "-".	DCTools/ Web: Alarms > Smart Alarms > Smart Alarm States
Change	The time and date when the Smart Alarm state last changed.	
Source Triggered	The present state of the source: Inactive Clear = The source condition is false and the alarm is not triggered. Inactive Armed = The source condition is false and the smart alarm input is active, because the source is set to <i>Invert</i> . Active Armed = The source condition is true and the smart alarm input is active. Active Clear = The source condition is true, but the smart alarm input is inactive because the source is set to <i>Invert</i> .  = There is an invalid dependency, or the source <i>Index</i> is invalid.  = The source is part of a circular dependency.	DCTools/ Web: Alarms > Smart Alarms > Sources
Next Activation	The date and time this schedule will next activate.	DCTools/ Web: Alarms > Smart Alarms > Schedule Sources
Schedule End	The date and time this schedule will activate for the last time.	

► To create a Smart Alarm

1 Determine the equivalent logic gate arrangement for the *Smart Alarm*.

 *Smart Alarms can be regarded as logic gates. Each gate (AND, OR or XOR) is an entry in the Smart Alarm States table. The gate inputs are entries in the Alarm Sources, Scheduled Sources or System Value Sources tables.*

2 Configure the Smart Alarm(s):

- On the web, go to: *Alarms > Smart Alarms*.
- Expand the *Smart Alarm States* table and configure a *Smart Alarm* and configure the following parameters.

 *To change a setting, double-click and select from drop down list or edit the text.*

Parameter	Setting
Name	Type the name of the alarm.
Severity	Set to the required alarm priority. This determines how the alarm is indicated. See details on page 52. If set to <i>Disabled</i> then the alarm will not activate.
Operator	Determines how the sources will be logically combined (AND, OR or XOR).
Recognition Period	The alarm will activate when the logical combination of the sources has been true for this period.
Deactivation Recognition Period	The alarm will deactivate when the logical combination of the sources has been false for this period.
Digital Output Mapping A	If required, select a relay that will be operated when the alarm is active.
Digital Output Mapping B	If required, select a second relay that will be operated when the alarm is active.
Send Trap	Depending on this setting, an SNMP Trap will be sent for this alarm, on activation or deactivation or both, if the alarm's <i>Severity</i> matches the setting of the SNMP Trap Level (see details on page 107).
Send Email	Depending on this setting, an email will be sent for this alarm on activation.
Group	Not normally used. Leave at zero.
Notes	Type any required description. When the alarm is active the text will be displayed on the SC300 web, the SC300 alarms detail view, and included in the SNMP trap (if used).

► To configure the Source(s) for a Smart Alarm

Configure the following parameters for the source(s) for each *Smart Alarm*.

 *Every Smart Alarm must have at least one Source assigned to it.*

Alarm Sources

Parameter	Setting
SA Num	Type the number (from the <i>Smart Alarm States</i> table) of the <i>Smart Alarm</i> for which this source is an input.
Status	Set to <i>Enabled</i> .
Trigger When Source Is	Set to either: Triggered - the Alarm Source will become active immediately when the conditions for this alarm become true (or false when <i>Logic</i> is set to NOT). The

alarm needs to be enabled and set with any severity, including Control.

 Do not use Triggered when Type is set to Smart Alarm.

Active - the Alarm Source will become active when the alarm becomes active (or inactive when Logic is set to NOT), after the alarm recognition time, and only if the alarm is Enabled.

Type	Set to the appropriate source type: <i>System Alarm, Analog Input High, Analog Input Low, DI, Smart Alarm.</i>
Index	Identify the alarm: <i>Source Type = System Alarm:</i> Web - select the name of the system alarm from the list. <i>Source Type = AI High/AI Low</i> - type the alarm number from the <i>Analog Input High Alarms</i> or the <i>Analog Input Low Alarms</i> table. <i>Source Type = DI</i> - type the alarm number from the <i>Digital Input Alarms</i> table. <i>Source Type = Smart Alarm</i> - type the alarm number from the <i>Smart Alarm States</i> table.
Invert	The source is inverted before it is used to trigger the <i>Smart Alarm</i> . The <i>Smart Alarm</i> will be triggered when the source becomes inactive.
Active Count	Sets the number of transitions before the Smart Alarm becomes active. E.g. If this is set to 2, then two inactive to active transitions are required before the Smart Alarm becomes active.
Inactive Count	Sets the number of transitions before the Smart Alarm becomes inactive. E.g. If this is set to 2, then two active to inactive transitions are required before the Smart Alarm becomes inactive.
Trigger	Specify how the source is used to trigger the <i>Smart Alarm</i> . <i>Level</i> - triggered as long as the source is active. <i>Edge Set</i> - triggered when the source becomes active. <i>Edge Reset</i> - triggered when the source becomes inactive <i>Edge Latch</i> - triggered when the source becomes active. The Smart Alarm remains active as long as the source is active.

Schedule Sources

Parameter	Setting
SA Num	Type the number (from the <i>Smart Alarm States</i> table) of the <i>Smart Alarm</i> for which this source is an input.
Status	Set to <i>Enabled</i> .
First Activation	Set to the date and time when the <i>Schedule Source</i> will activate for the first time (see the diagram below).
Duration	Set to the length of time that the <i>Schedule Source</i> will remain active each time it activates (see the diagram below).
Interval	Set to the time interval between the start of each activation (see the diagram below).
Number of Activations	Set the number of activations. <i>Schedule end</i> will show the last activation (if applicable). <i>If set to zero then there is no limit to the number of activations.</i>
Invert	The source is inverted before it is used to trigger the <i>Smart Alarm</i> . The <i>Smart Alarm</i> will be triggered when the source becomes inactive.

Trigger	Specify how the source is used to trigger the <i>Smart Alarm</i> . <i>Level</i> – triggered as long as the source is active. <i>Edge Set</i> – triggered when the source becomes active. <i>Edge Reset</i> – triggered when the source becomes inactive <i>Edge Latch</i> – triggered when the source becomes active. The Smart Alarm remains active as long as the source is active.
---------	---

Scheduled Sources Operation

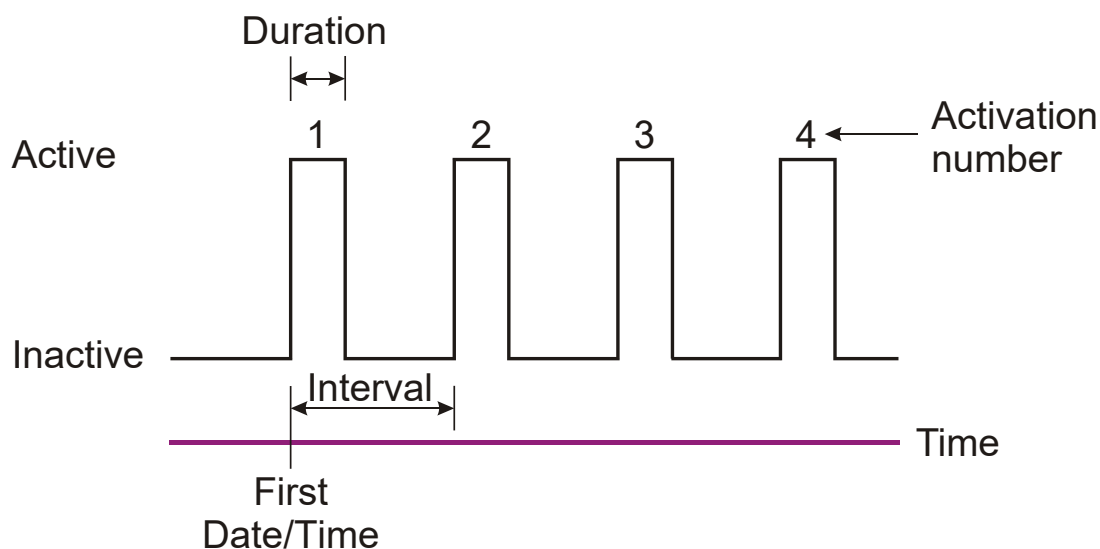

System Value Sources

Parameter	Setting
SA Num	Type the number (from the <i>Smart Alarm States</i> table) of the <i>Smart Alarm</i> for which this source is an input.
Status	Set to <i>Enabled</i> .
System Value	Set to the required value (<i>Bus Voltage, Rectifier Current, Load Current, Battery Current, Battery Temperature, Load Power, System Power, Ah Discharged, Number Of Rectifiers Failed, Number Of Rectifiers Comms Lost, AC Voltage, DC Input Voltage, Rectifier Input Voltage, Battery Time Remaining, Battery Health, Alternative Source Current, Solar Current, Solar Power, Generator Power, Highest Rectifier Heatsink Temperature, Fuel Level, Generator Backup Time, Fuel Remaining Time, Smart Analog, Energy Meter, Power Meter, Current Meter, Voltage Meter, Operating Voltage</i>).
System Value Index	Where the System Value is in a table of values, the position in this table. <i>This applies to Smart Analog, Energy Meter, Power Meter, Current Meter, and Voltage Meter items.</i>
Threshold Type	Set to either: High - the System Value Source will be true when the System Value goes above the Threshold. Low - the System Value Source will be true when the System Value goes below the Threshold.
Threshold	The System Value Source will be true when the System Value goes above or below (depending on the Threshold Type) this value.
Hysteresis	Determines when an active <i>System Value Source</i> will become false: If <i>Threshold Type</i> is set to <i>Low</i> the <i>System Value Source</i> will become false when

the *System Value* goes above *Threshold + Hysteresis*.

If *Threshold Type* is set to *High* the *System Value Source* will become false when the *System Value* goes below *Threshold - Hysteresis*.

Invert	The source is inverted before it is used to trigger the <i>Smart Alarm</i> . The <i>Smart Alarm</i> will be triggered when the source becomes inactive.
Invert	The source is inverted before it is used to trigger the <i>Smart Alarm</i> . The <i>Smart Alarm</i> will be triggered when the source becomes inactive.
Active Count	Sets the number of transitions before the <i>Smart Alarm</i> becomes active. E.g. If this is set to 2, then two inactive to active transitions are required before the <i>Smart Alarm</i> becomes active.
Trigger	Specify how the source is used to trigger the <i>Smart Alarm</i> . <i>Level</i> – triggered as long as the source is active. <i>Edge Set</i> – triggered when the source becomes active. <i>Edge Reset</i> – triggered when the source becomes inactive <i>Edge Latch</i> – triggered when the source becomes active. The <i>Smart Alarm</i> remains active as long as the source is active.

Manual Sources Parameter	Setting
SA Num	Type the number (from the <i>Smart Alarm States</i> table) of the <i>Smart Alarm</i> for which this source is an input.
Status	Set to <i>Enabled</i> .
Invert	The source is inverted before it is used to trigger the <i>Smart Alarm</i> . The <i>Smart Alarm</i> will be triggered when the source becomes inactive.
Trigger	Specify how the source is used to trigger the <i>Smart Alarm</i> . <i>Level</i> – triggered as long as the source is active. <i>Edge Set</i> – triggered when the source becomes active. <i>Edge Reset</i> – triggered when the source becomes inactive <i>Edge Latch</i> – triggered when the source becomes active. The <i>Smart Alarm</i> remains active as long as the source is active.
Period	If this setting is non-zero, the source will oscillate at this period. Alarm recognition and de-recognition times will affect the duty cycle of the alarm.

Smart Alarm Actions

A Smart Alarm may be configured to cause certain actions when the alarm is active. The Smart Alarm actions table specified which if any actions occur for any Smart Alarm.

Parameter	Setting
AC Peak Load Reduction Smart Alarm	To trigger Peak Load Reduction (PLR) from a Smart Alarm, set this number to the Smart Alarm number.
Equalize Smart Alarm	To trigger Equalize from a Smart Alarm, set this number to the Smart Alarm number.
Shutdown all rectifiers Smart Alarm	Shuts down all ac input rectifiers.
Shutdown all Solar Smart Alarm	Shuts down all dc input solar chargers.
Off-Normal Smart Alarm	When this is active, logs run at the Off-normal rate.
Alternative Float Smart alarm	When this is active, batteries are charged at the <i>Alternative Float Voltage</i> .

Example : AC High and AC Low Alarms

AC High and AC Low are examples of useful alarms that can be set up using *Smart Alarms*.

► To Create an AC High Smart Alarm

1 Configure a *Smart Alarm* with the following parameter settings:

Name: AC High
Operator: OR

Severity: Minor (or a different severity if required).

Set other parameters as required (see details on page 59).

- 2** Configure a *System Values Source* with the following parameter settings:

SA Num: The number of the *Smart Alarm* configured in step 1.
Status: *Enabled*
System Value: *AC Voltage*
Threshold Type: *High*
Threshold: 275 (or a different value if required)
Hysteresis: 5 (or a different value if required)
Invert: -
Trigger: Level

► **To Create an AC Low Smart Alarm**

- 1** Configure a *Smart Alarm* with the following parameter settings:

Name: AC Low
Operator: OR
Severity: Minor (or a different severity if required).

Set other parameters as required (see details on page 59).

- 2** Configure a *System Values Source* with the following parameter settings:

SA Num: The number of the *Smart Alarm* configured in step 1.
Status: *Enabled*
System Value: *AC Voltage*
Threshold Type: Low
Threshold: 185 (or a different value if required)
Hysteresis: 5 (or a different value if required)
Invert: -
Trigger: Level

Batteries

The following information is available about the batteries connected to the dc power system.
 See also *Battery Time Remaining* on page 70.

Parameter	Description	Where to find:
Battery Charge State	Charge - the battery current is above the <i>Battery State Threshold</i> .	SC300: Battery > Battery DCTools/Web: Batteries
	Discharge - the battery current is below -1 * <i>Battery State Threshold</i> .	
	Float - the battery current is between \pm <i>Battery State Threshold</i> .	

Unavailable - the battery current is not available.



See SC300 or Web displays ??? or N/A on page 118.

Battery Temperature	The temperature measured by the battery temperature sensor.
Ah Discharged	The current level of battery discharge. <i>See also Reset Ah Discharged on page 73.</i>
Battery State of Health	Refer to Battery Time Remaining on page 70.

Batteries Configuration

The following battery parameters must be configured.

Parameter	Description	Where to find:
Cells Per String	The number of 2V cells per battery string (for example: 24 in a 48V nominal system).	SC300: Battery > Battery (tab)
Battery Capacity	Set to the rated 10 hour capacity of the installed battery strings.	DCTools/Web: Batteries
Battery State Threshold	Used to determine the <i>Battery Charge State</i> . See <i>Battery Charge State</i> on page 65. Battery State Threshold should be set to no less than 1% of the maximum battery current full scale measurement (e.g. shunt current rating). <i>If this is set too low, Battery Charge State may be incorrect due to battery current measurement errors.</i>	
Battery Type	An optional text field for the name or type of battery.	DCTools/Web: Batteries
Ah Discharged Float Reset Rate	When the system is in float charging state, the Ah Discharged figure is decreased every hour by (Ah Discharged Float Reset Rate * Battery State Threshold). The default is 0.5 Ah / hour. This corrects any residual error.	
Battery Current Sensor Fail Recognition Period	An optional battery current sensor fail delay. Set if momentary battery current sensor fail conditions stop battery related control processes.	
End of Charge Action	Set Ah Discharged to zero after Equalize and Fast Charge, after Fast Charge only, or after Equalize only. Use this option to allow Equalize and / or Fast Charge to reset Ah Discharged, particularly in a cyclic charge situation where Ah Discharged will drift over time.	
Battery Installed Date	If required, this date can be entered for future reference.	

Battery Design End of Life Date If a date is entered here, and the *Battery End of Life* alarm is enabled, the *Battery End of Life* alarm will become active at this date.

Both Battery Installed Date and Battery End of Life Date must be set before the Battery End of Life alarm will work.

Site Backup Time Where a site has a known back-up time, enter that time here. During a discharge, *Site Backup Time Remaining* will count down from this figure. This gives users a quick view of the expected time left before the site power fails.

Battery Symmetry Monitoring

Mid-point Monitoring (MPM) and Quarter-point monitoring (QPM)

- The SC300 uses the same settings for MPM and QPM.*
- Where text refers to Battery Symmetry, it includes mid-point and quarter-point monitoring unless otherwise stated.*

Battery Symmetry Monitoring provides a cost-effective method for the early detection of internal battery faults.

The voltages of the two halves or quarters of a battery string are measured and the system controller generates an alarm signal if a voltage imbalance is detected.

A voltage imbalance is an indication that one or more cells has an internal fault. Further investigation can then isolate the faulty cell(s) and action can be taken to correct the problem and prevent a total battery failure.

To connect Battery Symmetry Monitoring see details in the dc power system Installation and Operation Guide. If a *String Fail* alarm is generated see Troubleshooting on page 117.

To ensure reliable operation Battery Symmetry Monitoring only operate when the battery is in float charge and after a configurable lockout period since the last battery discharge, Fast Charge, Equalize or Battery Test.

- Quarter-point monitoring requires the one of these IO Boards : IOBGP-10/11/20/21.*
- The IOBGP-00/01 only supports mid-point monitoring.*



► To enable Battery Symmetry Monitoring

- If any of the Battery Symmetry analog inputs are used for Reverse Battery Detection (see details on page 74) then they are not available for MPM/QPM.*
- 1** Connect the Battery Symmetry Monitoring sense wires to the batteries. Ensure short circuit protection is included at the battery end.
Refer to the dc power system Installation and Operation Guide.
 - There are four Battery Symmetry Monitoring analog inputs on an IOBGP Input / Output board. Up to 20 additional battery strings can be monitored if additional IOBGP Input / Output boards are connected. Refer to the dc power system Installation and Operation Guide for details on how to connect additional IOBGP Input / Output boards to the SC300.*
 - 2** In DCTools/Web go to *Batteries*.
 - 3** Set *Cells Per String* to the number of 2V cells per string (for example: 24 for 48V nominal system).
 - 4** Expand the *Battery Symmetry Monitoring* table.

- 5 Set *MPM Enable* to *Enabled* and check the configuration settings (see details on page 69).
- 6 For each MPM / QPM input, go to the Analog inputs table and configure the inputs as follows:

Analog inputs table configuration for each Battery Symmetry input

Parameter	Description	Where to find:
Status	Set to <i>Enabled</i>	
Name	For each Mid-point input, this should be the string name to be displayed in the MPM / QPM table. Quarter point input naming can be as required.	
Function	Set to <i>First Quarter Point</i> , <i>Mid-point</i> or <i>Third Quarter Point</i> as appropriate.	Web/DCTools: Analog Inputs
Function index	Set to the battery string number.	
IOB Number	Set to the correct value for the input.	
IOB AI number	Set to the correct value for the input.	
Gain	Leave at 1.	
Offset	Leave at zero	

-  The string name is taken from the name of the string mid-point as configured in analogue inputs. For instance "Batt Cab A string 1".
-  For Mid-point monitoring, battery strings 1-4 will typically be connected to IOB Number 1, IOB AI Numbers 2-5. Battery strings 5-8 will be connected to IOB Number 2, IOB AI Numbers 2-5. And so on, as required up to string 24.
-  For quarter-point monitoring, each string requires a Battery First Quarter Point, a Battery Midpoint, and a Battery Third Quarter Point input to be connected. Each IO Board can measure quarter-points for one string, plus one spare input. For instance, to monitor four strings requires 12 analog inputs, which can be achieved with three IO Boards.

- 7 Go to *Alarms > Alarm States*. Enable and configure the *String Fail* alarm. See System Alarm Configuration on page 54.

► To clear a **String Fail** alarm

- 1 On the web, go to *Batteries > Mid-point Battery Monitoring* (expand the table).
- 2 Click on *Clear String Fail*.

Information

The following information is available about Battery Symmetry Monitoring :

Parameter	Description	Where to find:
State	Disabled: No enabled analogue inputs are set to Function = Mid-point, first quarter-point, or - third quarter-point. Unable To Start: MPM is <i>Enabled</i> but either: <i>Cells per String</i> is zero; the bus voltage sensor has failed; ac supply has failed; the battery is in discharge state; Fast Charge, Equalize or Battery	

Parameter	Description	Where to find:
	<p>Test is active; or the battery fuse has failed.</p> <p>Locked Out: MPM is within the <i>MPM Lockout Period</i>. No <i>String Fail</i> alarm will become active in this period.</p> <p>Converging: MPM is outside the <i>MPM Lockout Period</i> but is within <i>MPM Convergence Period</i>.</p> <p>Stable: MPM is outside the <i>MPM Convergence Period</i>.</p>	
Time In This State	The time period Battery Symmetry Monitoring has been in the current state.	
Current Threshold	When State is <i>Converging</i> this value is between <i>Start Threshold</i> and <i>Stable Threshold</i> . When state is <i>Stable</i> this value is the <i>Stable Threshold</i> .	
Reference Voltage	The calculated mid-point reference voltage (50% of the bus voltage for even number of cells).	SC300: Battery > MPM DCTools/Web: Batteries > Battery Symmetry Monitoring
String State	<p>OK: Battery Symmetry Monitoring is in the state <i>Converging</i> or <i>Stable</i> and the string's <i>Imbalance</i> is below the current threshold.</p> <p>Unavailable: Battery Symmetry Monitoring is not in state <i>Converging</i> or <i>Stable</i>, or the string's mid-point voltage is unavailable.</p> <p>Pending Fail: The string's <i>Imbalance</i> is above the current threshold, but has not yet been so continuously for the <i>String Fail Recognition Period</i>.</p> <p>Fail: The string's <i>Imbalance</i> has been above the <i>Current Threshold</i> for longer than the <i>String Fail Recognition Period</i>. This will activate a <i>String Fail</i> alarm.</p> <p>Not Configured: No analog input is mapped to this string.</p>	
¼ Point Voltage	Shows the first quarter-point voltage reading for the string or <i>N/A</i> if no analog input channel is mapped to this string. <i>Only shown if an analog input is configured as Battery First Quarter Point.</i>	
Mid-point Voltage	Shows the mid-point voltage reading for the string or <i>N/A</i> if no analog input channel is mapped to this string.	
¾ point Voltage	Shows the third quarter-point voltage reading for the string or <i>N/A</i> if no analog input channel is mapped to this string. <i>Only shown if an analog input is configured as Battery Third Quarter Point.</i>	
Imbalance	The percentage imbalance of the <i>Mid-point Voltage</i> , or the worst imbalance of the ¼, mid and ¾ point if QPM is in use.	

Configuration

Set the following parameters.

Parameter	Description	Where to find:
-----------	-------------	----------------

String Fail alarm parameters	See System Alarm Configuration on page 54.	Web: Alarms > Alarm States
Lockout Period*	Time from when Battery Symmetry Monitoring is able to start until the start of the <i>Convergence Period</i> .	
Convergence Period*	Time from the end of the <i>Lockout Period</i> until <i>State</i> is <i>Stable</i> . During this period the <i>Current Threshold</i> is calculated using linear interpolation between <i>Start Threshold</i> and <i>Stable Threshold</i> and the <i>State</i> is defined as <i>Converging</i> . After this period the <i>State</i> is defined as <i>Stable</i> and the <i>M Stable Threshold</i> applies.	SC300: Battery > MPM > Settings
String Fail Recognition Period	If the mid-point / quarter point <i>Imbalance</i> percent of a battery string exceeds the <i>MPM Threshold</i> for this period of time the <i>String State</i> is set to <i>Fail</i> and the <i>String Fail</i> alarm is activated.	Web: Batteries > Battery Symmetry Monitoring
Start Threshold*	Mid-point / quarter point <i>Imbalance</i> percent threshold at the start of the <i>MPM Convergence Period</i> .	
Stable Threshold*	Mid-point / quarter point <i>Imbalance</i> percent threshold after the convergence period.	

* A dynamic alarm threshold is used to give the best possible battery fault detection:

- 1 After the end of a discharge, Fast Charge or Equalize cycle, Battery Symmetry Monitoring does not start until the end of the Battery Symmetry Monitoring *Lockout Period*, to ensure the system is in float charge.
- 2 At this point, the battery cell voltages are expected to be widely spread, so the alarm threshold is set high (*Start Threshold*).
- 3 The alarm threshold is then progressively reduced over the *Convergence Period*.
- 4 After the end of the *Convergence Period*, cell imbalance is assumed to be stable, and a fixed threshold is used (*Stable Threshold*).

Battery Time Remaining

The SC300 obtains characterization data from every full battery discharge, to a specified end voltage.

During a battery discharge, the SC300 uses this characterization data to calculate an estimated time until the battery will reach the specified end voltage.

- If a battery disconnect LVD is fitted, then the end voltage will usually be the voltage at which the LVD disconnects the battery.
- Battery Time Remaining is designed for a constant power load. The accuracy of the time remaining calculation will be reduced if the dc power system is connected to a predominantly resistive (constant current) load.
- The time remaining calculation will not be correct if a non-essential load is disconnected during the battery discharge.
- Battery Time Remaining cannot be used for very small battery strings (<20Ah) due to limits in current resolution.
- Battery characterization and Battery Time Remaining are not recommended under these conditions:
 - With a battery C10 capacity of less than 30Ah
 - If load current is less than twice the Battery State Threshold setting.

- If load current is less than 10A.

Configuration



It will take at least 10 hours to characterize a battery.

When a battery is characterized it is fully discharged. The bus voltage will gradually reduce to the battery end voltage. Ensure that this will not affect the operation of any equipment connected to the dc power system.

Use the following procedure to configure *Battery Time Remaining* for the first time, or if a previously characterized battery is changed.

- ☐ *Battery Characterization is not necessary if a previously saved battery characterization data file is available. Refer to Characterization Data Management on page 73. Only use characterization data for an identical type and size of battery.*

► To configure *Battery Time Remaining*

- 1 Check that all battery strings are connected and all LVD contactors (if any) are connected.
 - ☐ *During a battery characterization, LVD contactor disconnection is inhibited. If any LVD contactor is configured to connect during a battery discharge, then set it to Manual Connect to prevent operation during the battery characterization.*
- 2 Check that all battery strings are fully charged.
 - ☐ *When a battery is fully charged, the Battery Charge State will be Float and Ah Discharged will be zero. See Batteries on page 65.*
- 3 Check that all battery parameters are set to the correct values. See Batteries Configuration on page 66.
- 4 Check that the load current is at least 10% of the C10 capacity of the batteries (*Battery Capacity*) and at least 150% of the *Battery State Threshold*. See Batteries Configuration on page 66.
 - ☐ *If the load current is less than 10% of the C10 capacity of the batteries, then Battery Characterization will take longer than 10 hours.*
- 5 From the Web go to *Batteries > Battery Time Remaining*, or use the SC300 keypad to go to *Battery*. Set *End Voltage* to the voltage per cell when the battery is regarded as fully discharged.
 - ☐ *In general, set the end voltage to the same value as for the LVD Disconnect Voltage (see LVD Configuration on page 50). End Voltage must be at least 0.02V/Cell above the Minimum System Voltage (per cell). The Minimum System Voltage is viewable on the web at Control Processes. It is not configurable from web.*
- 6 Enable *Battery Current Limit* (see details on page 29).

► To Characterize the Battery

- 1 Either:
 - Manually start a Characterization:
On the SC300 go to: *Battery > Characterize > Start*.
On DCTools/web go to: *Battery > Battery Time Remaining*. Click *Characterize*.
 - ☐ *If "Characterize" is not present on the SC300 or the "Characterize" button is inactive in Web, then check all configuration settings. In Web, the hover text will indicate why the characterization cannot start.*
 - Or, use *Automatic Characterization* to start a characterization automatically when all conditions are correct and stable:
On the web, to: *Battery > Battery Time Remaining*.
Set *Automatic Characterization* to *Enabled* and set *Automatic Characterization Delay*

to the required time that the conditions must be stable.

- 2 The characterization process will take at least 10 hours, depending on the load current.
 - During characterization the rectifier output voltage is varied to maintain a constant power discharge.
- 3 When the characterization has finished, the *Characterization Result* will be *Updated*.
 - If any other *Characterization Result* is shown, refer to *BTR Operation on page 72*.
- 4 The rectifiers will return to float voltage and the battery will start to recharge. If required, start a manual Equalize (see details on page 32) to reduce the battery recharge time.
- 5 Restore any changed LVD operation back to the original settings. If no longer required, disable *Battery Current Limit*.

Battery Time Remaining is now operational. During any battery discharge an estimate of time remaining will be displayed.

Operation

The following information is available about *Battery Time Remaining*.

Parameter	Description	Where to find:
Time Remaining	<p>During a battery discharge, this is the estimated time until the battery voltage will be equal to the <i>End Voltage</i>, at the present battery current. Time remaining will be re-calculated if the load current varies during discharge (for example, when a load disconnect LVD operates).</p> <p>□ <i>Time Remaining is only available when Battery Time Remaining State is Active.</i></p>	<p>SC300: Battery Web/DCTools: Batteries</p>
Battery State Of Health	<p>The approximate battery capacity measured during the last battery characterization, as a percentage of the configured <i>Battery Capacity</i>.</p>	<p>Web/DCTools: Batteries</p>
State	<p>Inoperative: The battery characterization data is not loaded, <i>End Voltage</i> is below the characterization end point, or the bus voltage or battery current is unavailable.</p> <p>Inactive: <i>Battery Charge State</i> is <i>Float</i> or <i>Charge</i>.</p> <p>□ See <i>Battery Charge State</i> on page 65.</p> <p>Characterizing: Battery characterization is in progress.</p> <p>Active: The battery has been characterized and <i>Battery Charge State</i> is <i>Discharge</i>.</p> <p>□ See <i>Battery Charge State</i> on page 65.</p>	<p>SC300: Battery Web/DCTools: Batteries > Battery Time Remaining</p>
Lowest End Voltage	<p>The end voltage used for the last battery characterization.</p>	
Characterization Result	<p>Not Yet Run: The battery has not been characterized since the last restart of the SC300.</p> <p>Active: The SC300 is collecting the characterization data.</p> <p>Complete: The SC300 has collected the characterization data and is updating its</p>	

Parameter	Description	Where to find:
	<p>database.</p> <p>Updated: The SC300 has updated its database.</p> <p>Sensor Failed: Data from the last characterization was not saved because the bus voltage sensor failed or the battery current became unavailable.</p> <p>Not Fully Charged: Characterization did not start because the battery was not fully charged when discharge started.</p> <p>Unstable Battery Current Pending: The battery current has varied more than the tolerance for an accurate characterization. Characterization will continue if the battery current is in tolerance within two minutes. Otherwise, data from this discharge will not be saved.</p> <p>Unstable Battery Current: Data from the last characterization was not saved because the battery current varied more than the tolerance, for more than two minutes.</p> <p>Voltage Step Detected: Data from the last characterization was not saved because of a change in the bus voltage (possibly caused by a load disconnect).</p> <p>Canceled: Data from the last characterization was not saved because the characterization was stopped manually.</p>	

Characterization Data Management

Battery characterization data can be saved to file for later use. This is useful if several sites use batteries of the same type and size. However, characterization of each battery will provide the most accurate estimate of *Time Remaining*.

► To save characterization data to a file

- 1 In Web go to *Batteries > Battery Time Remaining*.
- 2 When the battery characterization is completed, click on *Characterization Data: Download*.
- 3 Click *Save*. Type a file name (*.dcf) and browse to the required location. Click *Save*.

 *DCTools cannot save the characterization data.*

► To load battery characterization data into the SC300

Use Web to restore the *.dcf (configuration fragment) file previously saved. Refer to Backup and Restore on page 25.

Reset Ah Discharged

The SC300 monitors battery discharge and maintains a value called *Ah Discharged*. In a new SC300 *Ah Discharged* is set to zero. During operation of the dc power system the value is increased as the battery is discharged, and reduced as the battery is recharged.

The value of *Ah Discharged* is used to start the *Fast Charge* control process. See details on page 33.

► To view current value of Ah Discharged

- Use the SC300 keypad to go to: *Battery > Battery > Ah Discharged*

- On the web, the Ah Discharged value is shown next to the battery icon.
- Or go to: *Batteries*.

If a battery or the SC300 is changed, then reset the value of *Ah Discharged* to zero (when the battery is fully charged).

► **To set the value of Ah Discharged back to zero**

- Use the SC300 keypad to go to: *Battery > Reset State > Enter > Reset*.
- Or, on the web or DCTools, go to: *Batteries*. Click *Reset Ah Discharged*.
 Any active or pending Fast Charge or Equalize will be cancelled.

Reverse Battery Detection

If *Reverse Battery Detection* is enabled and a battery is connected with the incorrect polarity, the SC300 will:

- Activate a *Wrong Battery Polarity* alarm, and
- Prevent any LVD from connecting.

Reverse Battery Detection uses the battery symmetry analog inputs on an IOBGP Input / Output board. Any of the mid-point monitoring analog inputs used for Reverse Battery Detection are not available for MPM or QPM (see details on page 67).

► **To enable Reverse Battery Detection**

- 1 Before the batteries are connected to the dc power system, connect the mid-point monitoring sense wires to the battery sides of the battery fuses/disconnect devices (leave the fuses/disconnect devices open). Refer to the dc power system Installation and Operation Guide.

There are four mid-point monitoring analog inputs on an IOBGP Input / Output board (for four battery fuses/disconnect devices). Up to 20 additional battery fuses/disconnect devices can be connected if additional IOBGP Input / Output boards are connected. Refer to the dc power system Installation and Operation Guide for details on how to connect additional IOBGP Input / Output boards to the SC300.

- 2 On DCTools/web, go to *Analog Inputs* and for each mid-point monitoring analog inputs used (one per battery fuses/disconnect devices) set the following parameters.

To change a setting, double-click and select from drop down list or edit the text.

Parameter	Setting
Status	Set to <i>Enable</i> .
Name	Set to: <i>Battery Polarity Detect 1, Battery Polarity Detect 2, ...</i>
Function	Set to <i>Reverse Battery Detect</i> .
Units	Set to <i>Volts</i> .
IOB Number	Set to 1 for battery fuses/disconnect devices 1-4. Set to 2 for battery fuses/disconnect devices 5-8. ...
IOB AI Number	Set to 2 for battery fuses/disconnect devices 1, 5, 9 ... Set to 3 for battery fuses/disconnect devices 2, 6, 10
Gain	Set to 1.

Offset	Set to 0.
Group	Set to 0 unless using Groups in PowerManagerII. See PowerManagerII online help for details.

- 3 On DCTools/web, go to Alarms > Alarm States table, and check the Wrong Battery Polarity alarm is enabled.
- 4 If necessary, expand the table and enable the Wrong Battery Polarity alarm.

Wrong Battery Polarity Alarm

If *Reverse Battery Detection* is connected and enabled, the SC300 will activate a *Wrong Battery Polarity* alarm if it detects that one or more of the batteries are connected with the wrong polarity.

Generator Control

 In some installations, particularly off-grid, Smart Alarms are configured to control the generator. In this case, refer to the system documentation for details on generator control. The information below will not apply.

Generator Control is used to delay the start of a standby ac generator until the batteries are partially discharged (rather than immediately after the ac supply fails). This can save fuel by preventing the generator running during short ac supply failures. It can also be used to control a generator in a hybrid power system (cyclic charge/discharge).

Generator Control uses a digital output (relay) which is connected in series with the generator run signal of the generator controller. The relay contacts interrupt the generator run signal until the *Generator Control* is active.

The *Generator Control* output is activated and deactivated depending on the *Start Generator* settings. The options are:

- *Start generator on fast charge* - The controller will activate the generator control relay while *Fast Charge* is active or pending, and deactivate it when the *Fast Charge* cycle ends.
- *Start generator on equalize* - The controller will activate the generator control relay while *Equalize* is active, and deactivate it when the *Equalize* cycle ends.
- *Start generator on AC Peak Load Reduction* - The controller will activate the generator control relay when *PLR* is active, and the battery has discharged down to the *PLR Low Voltage Limit* and deactivate it when the battery is fully charged (as indicated by *Ah Discharged* is zero).
- *Start generator on mains failure* - The controller will activate the generator control relay when an ac supply failure is detected, and deactivate it when the ac supply is restored.

A *Generator Fail* alarm is activated if the SC300 does not detect that the ac supply is present (rectifiers have turned on) after the *Generator Fail Alarm Recognition Period* following *Generator Control* becoming active.

The generator can also be started and stopped manually.

The SC300 detects that the generator is running from a digital input. There must be a digital input connected that is active when the generator is running. This should be configured with *Function* = *Engine Run*.

► To manually start the generator

- Make sure that *Maximum Run Time* has been set to a value greater than zero.
- Use the SC300 keypad to go to: Control Processes > Generator Control > Settings (tab) and select *Start Manual Run*.
- On DCTools/web, go to Control Processes > Generator Control > Manual Run and click *Start*.

► **To manually stop the generator after a manual start**

- Use the SC300 keypad to go to: Control Processes > Generator Control > Settings (tab) and select *Cancel Manual Run*.
- On DCTools/web, go to Control Processes > Generator Control > Manual Run and click *Cancel*.

☐ This will not stop the generator if it is running due to a Fast Charge, Equalize, or AC failure.

When the generator has been started manually, *Generator Run Time Remaining* shows the time remaining for the generator to run.

► **To view Generator Run Time Remaining**

- Use the SC300 keypad to go to: Control Processes > Generator Control.
- On DCTools/web, go to Control Processes > Generator Control.

Single line diagram

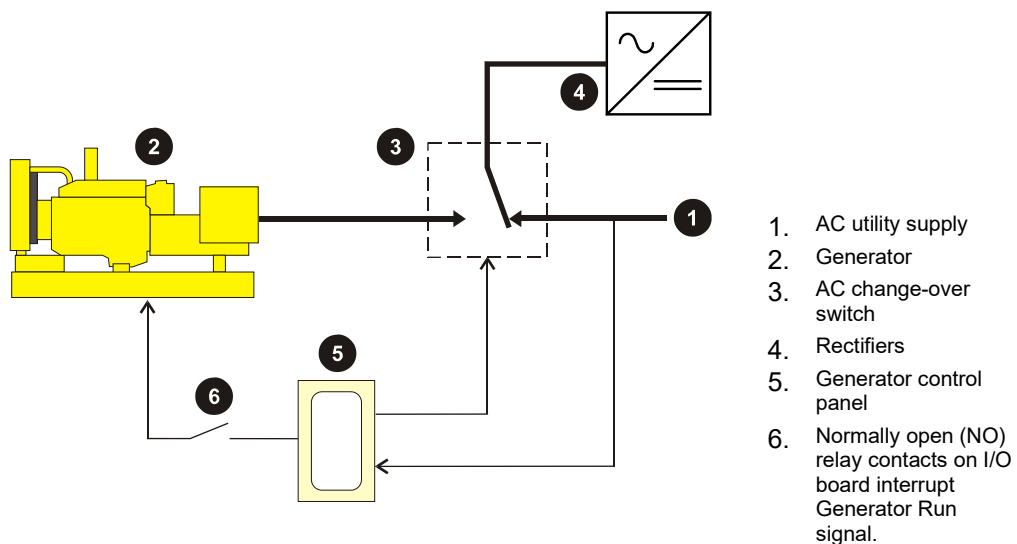

Typical operation for systems with an ac supply

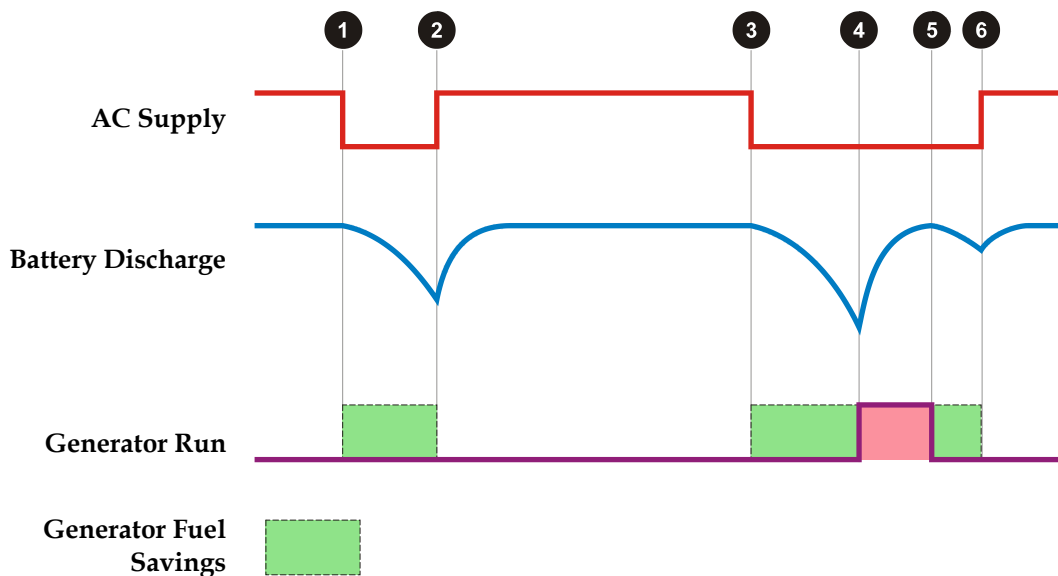

1. AC supply failure. Battery starts to discharge.
2. AC supply restored. Battery begins to recharge. Battery discharge did not reach the Ah Threshold. The Generator Control output was not active (relay contacts did not close) so the generator did not run.

3. AC supply failure. Battery starts to discharge.
4. Battery discharge reaches the Ah Threshold. The Generator Control output becomes active and the relay contacts close. The Generator Run circuit is completed allowing the generator to start. Battery begins to recharge.
5. Battery recharge is complete. The Generator Control output becomes inactive and the relay contacts open. The Generator Run circuit is interrupted causing the generator to stop. Battery begins to discharge.
6. AC supply restored. Battery begins to recharge. Battery discharge did not reach the Ah Threshold. The Generator Control output was not active (relay contacts did not close) so the generator did not run.

Typical operation for hybrid power systems

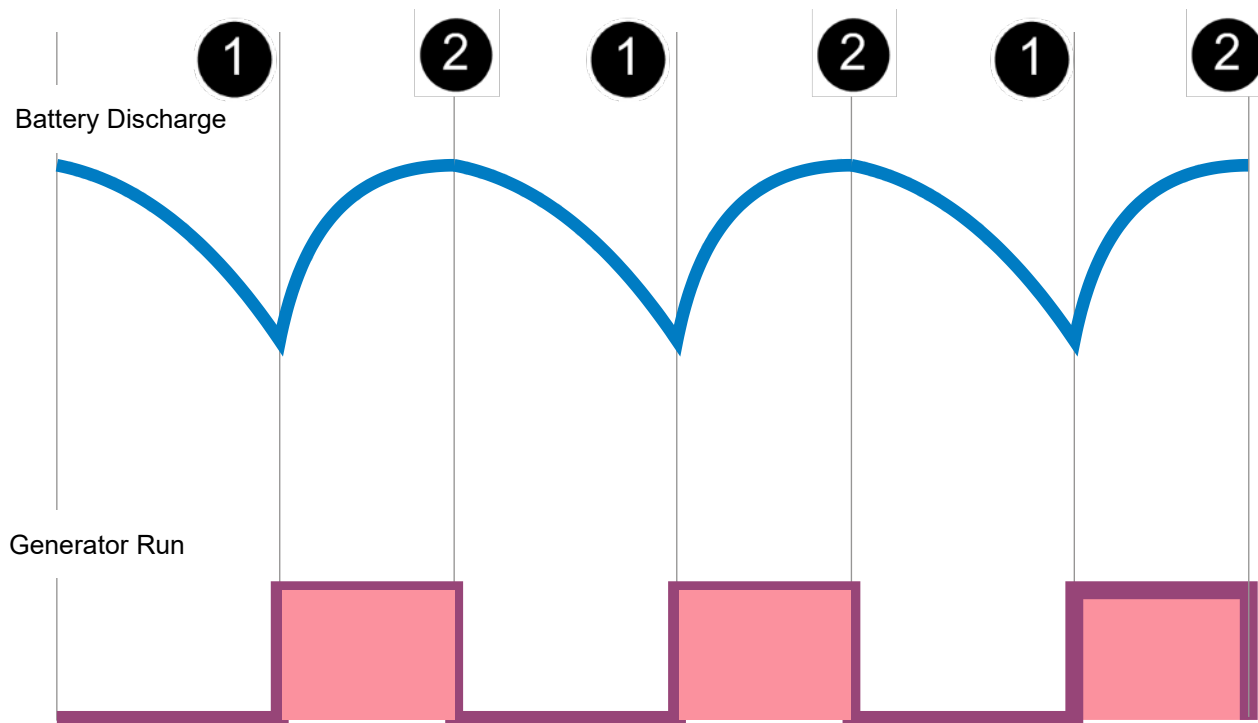

1. Battery discharge reaches the Ah Threshold. The Generator Control output becomes active and the relay contacts close. The Generator Run circuit is completed allowing the generator to start. Battery begins to recharge.
2. Battery recharge is complete. The Generator Control output becomes inactive and the relay contacts open. The Generator Run circuit is interrupted causing the generator to stop. Battery begins to discharge.

Configuration

► To set up Generator Control:

- Connect from the normally open (NO) contacts of an unused digital output relay on the I/O board to the generator run circuit.
 - ☐ Ensure that no alarms are mapped to this relay.
- On the web, go to *Digital Outputs* and configure the digital output as *Active State Energized*. See *Digital Outputs* on page 88.
- Connect a spare digital input to a volts free contact that closes when the generator is running. Configure this with *Function = Engine Run*.
 - ☐ This contact tells the SC300 that the generator is actually running, and allows it to determine if the generator has failed.
- Check that *Fast Charge* is enabled, and check the *Fast Charge* configuration settings. See *Fast*

Charge Configuration on page 34.

- Set the following parameters:

Parameter	Description	Where to find:
Start generator on fast charge	The controller will activate the generator control relay while <i>Fast Charge</i> is active or pending, and deactivate it when the <i>Fast Charge</i> cycle ends.	
Start generator on equalize	The controller will activate the generator control relay while <i>Equalize</i> is active, and deactivate it when the <i>Equalize</i> cycle ends.	
Start generator on AC Peak Load Reduction	The controller will activate the generator control relay when <i>PLR</i> is active, and the battery has discharged down to the <i>PLR Low Voltage Limit</i> and deactivate it when the battery is fully charged (as indicated by <i>Ah Discharged</i> is zero).	SC300: Control Processes > Generator Control > Settings (tab)
Start generator on mains failure	The controller will activate the generator control relay is an AC supply failure is detected, and deactivate it when the ac supply is restored.	DCTools/Web: Control Processes > Generator Control
Control Relay	The relay used to control the generator startup and shutdown. If this is set to <i>None</i> , the generator control process is disabled.	
Startup wiring	Set to <i>Direct Start</i> if the SC300 has full control of generator start. Set to <i>Indirect Start</i> if the system is wired so that the generator will automatically start when ac fails unless the Control Relay is opened by the SC300.	
Maximum Run-Time	The maximum time the generator is permitted to run following a manual start.	
Battery capacity	The rated 10 hour (C10) capacity of the installed battery strings.	SC300: Battery > Battery or DCTools/Web: Batteries.
Generator Fail Alarm Recognition Period	A <i>Generator Fail</i> alarm is activated after this time if the Generator Control output is active but the ac supply has not been restored.	SC300: Alarms > Settings (tab) DCTools/Web: Alarms > Alarm Configuration

Fuel Management

The SC300 can monitor the use of fuel by a standby generator.

► To set up fuel management

- Connect a fuel level sensor to an analog input. The fuel level sensor should have a 0 to 10V output if connected to an IOBSS or IOBGP analog input.
- On the web, go to: *Analog Inputs*.
- Configure the selected Analog Input and set *Function* to *Fuel Level*.
- Go to: *Control Processes > Generator Control* and set *Fuel Tank Volume*.

The following information is available about fuel usage.

Parameter	Description	Where to find:
-----------	-------------	----------------

Fuel Level	The volume of fuel in the generator's fuel tank.	
Generator Refuel Date	The time and date the generator was last refueled.	
Last Refuel Volume	The amount of fuel added to the generator's fuel tank during the last refuel.	
Generator Backup Time	The estimated time for which the generator could continuously run based on the current fuel level and historical fuel consumption.	SC300: Control Processes > Generator Control Web: Control Processes > Generator Control
Tank Empty Estimate	The best current estimate of the date the fuel tank will run dry if the current characteristics of generator usage and fuel consumption do not change. This is useful for installations that run the generator regularly and with a reasonably constant duty cycle.	

The time remaining estimates will not be accurate if the generator has been replaced or if the typical usage pattern has changed. If this happens, the fuel consumption history can be cleared manually.

 *Clearing the fuel consumption history will cause the time remaining estimates to be inaccurate or not available until enough information about the new generator has been collected.*

► **To clear the fuel consumption history**

- On the web, go to: *Control Processes > Generator Control > Clear Fuel Consumption History.*

Smart Alarms based on System Value Sources can be used to configure alarms based on:

- Fuel Level.
- Generator Backup Time.
- Fuel Remaining Time (this is the estimated *Tank Empty Date*).

See Smart Alarms on page 57 for details of how to set Smart Alarms.

Input/Output (I/O)

The following section describes the I/O functions available with a single IOBGP I/O board.

 *Also see I/O Board Mapping on page 139.*



Optional SiteSure-3G Input / Output (I/O) modules or additional IOBGP I/O boards can be connected to the SC300 to provide additional I/O to monitor and control external devices. For details refer to the SiteSure-3G Installation Guide (see Related Information on page i).

Identify an I/O Board

Input /Output (I/O) boards and SiteSure-3G modules are referenced by their serial numbers.

► **To identify a particular I/O board or SiteSure-3G module**

Either:

- On SC300 keypad go to: *Settings > IOBs* and select a module or board. Press *Enter*.
 *The I/O board details screen appears. Use   to scroll to other I/O boards.*
- The Power-on LED on the selected I/O board or SiteSure-3G module will flash for 60 seconds (or press *Esc* to stop).

Or:

- On the web, go to: *System > Interfaces > RXP > RXP Devices.*
- Web: click on *Start Identifying.*

- The Power-on LED on the selected I/O board or SiteSure-3G module will flash for 60 seconds.

Analog System Values

The SC300 provides access to the following system analog values.

Parameter	Description	Where to find:
Bus Voltage	The average of all analog inputs configured as <i>Bus Voltage</i> . Otherwise, the system bus voltage is determined from the rectifier output voltages.	
Load Current	The sum of any analog inputs configured as <i>Load Current</i> . Otherwise, if <i>Battery Current</i> is available, the <i>Load Current</i> is calculated as <i>Rectifier Current</i> + <i>Alternative Source Current</i> - <i>Battery Current</i> . Otherwise it is unavailable.	
Rectifier Current	The sum of any analog inputs configured as <i>Rectifier Current</i> . Otherwise, if there are <i>Battery</i> and <i>Load Currents</i> , the <i>Rectifier Current</i> is calculated as <i>Battery Current</i> + <i>Load Current</i> - <i>Alternative Source Current</i> . Otherwise, <i>Rectifier Current</i> is determined as the sum of all reported rectifier output currents.	
Battery Current	The sum of any analog inputs configured as <i>Battery Current</i> . Otherwise, if <i>Load Current</i> is available, the <i>Battery Current</i> is calculated as <i>Rectifier Current</i> + <i>Alternative Source Current</i> - <i>Load Current</i> . Otherwise it is unavailable. If positive, the battery is being charged.	SC300: Analogs
Solar Current	The total current produced by Solar Chargers controlled by the SC300. <i>Only visible if there are Solar Chargers present.</i>	DCTools: Analog Inputs > System Values
Alternative Source Current	The total current measured by all analog inputs configured as <i>Function = Alternative Energy Source Current</i> , plus the total current of all solar chargers controlled by the SC300. <i>Only visible if there are Alternative Energy Sources present and enabled in the analog input configuration.</i>	Web: Analog Input / Output > Analog Inputs > System Values
Sum of Reported Rectifier Currents	The sum of the currents reported by all rectifiers. Where there is no analog input configured as <i>Rectifier Current</i> , this will be the same value as <i>Rectifier Current</i> .	
Load Power	The power being supplied to the load. <i>Load Current</i> x <i>Bus Voltage</i> .	
System Power	The output power of the system as a percentage of the total nominal power of the registered rectifiers.	
Solar Power	The total power produced by all solar chargers controlled by the SC300. <i>Only visible if there are Solar Chargers present.</i>	
Phase 1	The AC input phase 1 voltage <i>Only visible if the SC300 is measuring ac input phases. Refer to Phase Detection on page 41.</i>	

Phase 2	The AC input phase 2 voltage <i>Only visible if the SC300 is measuring ac input phases. Refer to Phase Detection on page 41.</i>
Phase 3	The AC input phase 3 voltage <i>Only visible if the SC300 is measuring ac input phases. Refer to Phase Detection on page 41.</i>
AC Voltage	The average of the ac voltage measured by single-phase rectifiers. Or, if 3-phase rectifiers are fitted then the average of the ac phase voltages is shown.
Highest Rectifier Heatsink Temperature	The highest temperature reported by any rectifier.
Fuel level	The calculated fuel tank level if <i>Fuel Tank Volume</i> has been set.
Battery Temperature	The average of all analog inputs configured as <i>Battery Temperature</i> .

Analog Inputs

The analog inputs (AI) monitor variable dc voltages (bus voltage sense, general purpose analog inputs, current sensors or temperature sensors). See Specifications on page 123 for details.

Generally, the system analog inputs (as indicated by the "Function" field) are configured at the factory and do not need to be changed.

► To configure an analog input

- 1 On DCTools/web, go to *Analog Inputs*. Expand the *Analog Inputs* table.

The table shows the maximum number of analog inputs. The actual number of analog inputs available depends on the number of I/O boards or modules connected.

- 2 Select an Analog Input. The analog inputs are mapped to specific I/O connectors and are of three types (voltage/general purpose, current or temperature). See mapping tables on page 139.

If needed, more than one analog input can be mapped to the same connector so that the sensor can trigger more than one Analog Input High and/or Low Alarm. In this case, no more than one analog input can be assigned to a system function.

- 3 Configure the following parameters to suit the application.

To change a setting, double-click and select from drop down list or edit the text.

Parameter	Setting
Status	Set to <i>Enabled</i> .
Name	Type the name of the input or use the default value.
Function	Set to <i>User Defined</i> , or to a particular system function if the input is to be associated with that function.
Function Index	Where <i>Function</i> is set to <i>Fan Temperature</i> or <i>Smart Analog</i> , this specifies which input applies. Also used for MPM / QPM inputs to specify the battery string number for this input.
Units	Select the units to match the type of analog value.
IOB Number	The number of the I/O board or module. <i>Generally, do not change this mapping. See point 2.</i>
IOB AI Number	The number of the AI on the I/O board or module. <i>Generally, do not change this mapping. See point 2.</i>
Gain	A scaling factor applied to the raw measured value.
Offset	A fixed value added to the raw measured value (after any Gain is applied).
Group	Set to 0 unless using Groups in PowerManagerII. Refer to PowerManagerII online help.

Analog Input High and Low Alarms

Any analog input that is *Enabled* in the *Analog Inputs* table can activate a high and/or low alarm.

The Alarm Recognition Period (see details on page 54) applies to analog input alarms.

Configure the following parameters in the *Analog Input High Alarms* and/or *Analog Input Low Alarms* tables to suit the application.

To change a setting, double-click and select from drop down list or edit the text.

Parameter	Setting
-----------	---------

Severity	Set to the required alarm priority. This determines how the alarm is indicated. See details on page 52. If set to <i>Disabled</i> then the alarm will not activate.
Threshold	An analog input high/low alarm is activated if the scaled input is greater than/less than or equal to this value.
Hysteresis	The amount of hysteresis applied to the input before an active alarm is deactivated.
Digital Output Mapping A	If required, select a relay that will be operated when the alarm is active.
Digital Output Mapping B	If required, select a second relay that will be operated when the alarm is active.
Send Trap	Depending on this setting, an SNMP Trap will be sent for this alarm, on activation or deactivation or both, if the alarm's <i>Severity</i> matches the setting of the SNMP Trap Level (see details on page 107).
Notes	Type any required description. When the alarm is active the text will be displayed on the SC300 and included in the SNMP trap (if used).

Smart Analogs

Smart Analogs provides a means to add, average or multiply analog input or system values.

For example:

- Add the current from three outputs to give total "Load A" current.
- Average two temperature readings to give "Average cabinet temperature".
- Subtract outside temperature from inside temperature to give "Temperature rise"
- Multiply Bus Voltage times Alternative Energy Input Current to give Wind Generator Power
- Set a value to zero if a Smart alarm is active.

 *Smart analogs are not visible on the SC300 front panel, unless the Main Screen values have been set to Smart Analog. Refer to Main Screen Parameters, page 13 for more details.*

Smart Analogue Values

Parameter	Description	Where to find:
Smart Analog	The value of the Smart Analog calculated by the SC300.	
Smart Analog Average	The average value over the last Smart Analog log interval.	DCTools:
Smart Analog Min	The minimum value over the last Smart Analog log interval.	Analog Inputs > Smart Analogs
Smart Analog Max	The maximum value over the last Smart Analog log interval.	Web: Input / Output > Smart Analogs
Units	The units of the Smart Analog. The SC300 takes the units from the first analog input mapped to this <i>Smart Analog</i> for Addition and Average. For Multiplication, units are kilowatts.	

► To configure a Smart Analog

- 1 Create an entry in the Smart Analogs table for each sum, product or average value to be

calculated.

- 2 For each of the analog input values to be added, multiplied or averaged, create an entry in the Analog inputs table and set *Function = Smart Analog*. Set *Index = Smart Analog* number as above.

All the Analog inputs mapped to the same Smart Analog are then added, multiplied or averaged according to the *Type* setting.

- 3 For each of the system values to be added, multiplied or averaged to produce the Smart Analog value as above, create an entry in the System Values Mapping table.

In the Analog Inputs table, more than one analog input table entry can be mapped to the same physical input. This allows you to create an entry to map an input to a Smart Analog, even if it is already used for another Function.

The web view includes a copy of the Analogue inputs table to enable easy configuration of Smart Analogues. Only the columns relevant to Smart Analogues are shown. The items shown in this table are the same items as in the Analogue Inputs table.

To subtract an analog value, create an entry in the Analog Input table with a negative gain. This will make the value negative, so it will be subtracted from the other positive value(s).

- 4 Configure the Smart Analog values as below:

Parameter	Description
Name	Type the name of the <i>Smart Analog</i> .
Function	Maps a Smart Analog to a particular function. e.g. Set to <i>Smart Analog</i> to use this value as an input to another Smart analog. Set to <i>Load Current</i> to use this Smart Analog value as the system load current value.
Func Index	In some cases, an index will apply to the Function. e.g. Smart Analog requires an index.
Type	Set to: <ul style="list-style-type: none"> • Average to average them • Addition to add all the analog inputs mapped to this <i>Smart Analog</i> • Multiplication to multiply them together. • kMultiplication to multiply them together and multiply by 1000. Useful for instance where output is to be in kW • Max to set the Smart Analog to the maximum input • Min to set the Smart Analog to the minimum input
Gate	This limits values to a particular range: <ul style="list-style-type: none"> • Normal – no limit • Positive only – positive values only; negative values become zero. • Negative only – negative values only; positive values become zero. • Absolute – absolute value. Converts negative values to positive. • Change – sets the Smart Analogue to the rate of change per minute.

Use	This tells the SC300 to set the Smart Analogue value to the minimum, maximum or average of the calculated value, measured over the last Smart Analogues Log period
Smart Alarm Index	<ul style="list-style-type: none"> If this is zero, the Smart Analog is not affected. If this is non-zero, the Smart Analogue value will be N/A when this Smart Alarm is inactive, and normal if it is active.
Group	Do not use

System States

The SC300 monitors the following system states to provide an overview of the dc power system's operation. States displayed will depend on the dc power system model. Some states will only be displayed if there is a digital input configured for this function. For instance, the state *Fan* will only be displayed if there is a digital input configured with Function = ACD Fan Fail or Cabinet Fan Fail.

Name	Description	Where to find:
Fan	Indicates if any digital input with <i>Function</i> set to "ACD Fan Fail" is active (only appears if there is a digital input with <i>Function</i> set to <i>ACD Fan Fail</i>).	
Cabinet Fan	Indicates if any digital input with <i>Function</i> set to "Cabinet Fan Fail" is active (only appears if there is a digital input with <i>Function</i> set to <i>Cabinet Fan Fail</i>).	
Mains Fail	Indicates if any digital input with <i>Function</i> set to "AC Fail" is active. (only appears if there is a digital input with <i>Function</i> set to <i>Mains Fail</i>).	
MOV	Indicates if any digital input with <i>Function</i> set to "MOV Fail" is active (only appears if there is a digital input with <i>Function</i> set to <i>MOV Fail</i>).	SC300: Digitals DCTools: Digital Inputs Web: Input / Output > Digital Inputs
Load Fuse	Indicates if any digital input with <i>Function</i> set to "Load Fuse Fail" is active (only appears if there is a digital input with <i>Function</i> set to <i>Load Fuse Fail</i>).	
Battery Fuse	Indicates if any digital input with <i>Function</i> set to "Battery Fuse Fail" is active (only appears if there is a digital input with <i>Function</i> set to <i>Battery Fuse Fail</i>).	
Phase	Indicates if any digital input with <i>Function</i> set to "Phase Fail" is active. (only appears if there is a digital input with <i>Function</i> set to <i>Phase Fail</i>).	

Notes:

- 1 See the related Alarm Descriptions on page 127.
- 2 A value of *Unavailable* indicates that a System State is not configured for this dc power system.
- 3 A value of *Missing* indicates that the I/O board has been disconnected or is faulty, or the connector mapping is incorrect.

Digital Inputs

The Input / Output (I/O) board is fitted with a number of configurable digital inputs (DI) which can monitor external voltage-free relay contacts or switches. See Input / Output Board on page 2

for details.

► **To configure a digital input**

- 1 On DCTools/web, go to *Digital Inputs*. Expand the *Digital Inputs* table.

The number of digital inputs available for user digital inputs depends on the IO Board version. Refer to the *I/O Board (IOBGP-xx) Connector Pin-outs* on page 132 for IO Board input numbers.

If additional I/O boards and/or SiteSure-3G modules are connected, there will be more configurable Digital Inputs. See details in the *dc power system Installation and Operation Guide*.

Some digital inputs are normally configured as Digital System States (see details on page 86). Only use these inputs if you do need to use them as Digital System State Inputs.

- 2 Select a configurable Digital Input.

- 3 Configure the following parameters to suit the application.

To change a setting, double-click and select from drop down list or edit the text.

Parameter	Setting
Status	Set to <i>Enabled</i> .
Name	Type the name of the input.
Function	Set to <i>User Defined</i> .
IOB Number	The number of the I/O board (or SiteSure-3G module if connected). Do not change.
IOB DI Number	The number of the DI on the I/O board (or SiteSure-3G module if connected). Do not change.
Active State	Select the state of the input that will activate the DI.
Group	Set to 0 unless using Groups in PowerManagerII. See PowerManagerII online help for details.

Digital Input Alarms

Any digital input that is *Enabled* in the *Digital Inputs* table can activate an alarm.

Configure the following parameters in the *Digital Input Alarms* table to suit the application.

To change a setting, double-click and select from drop down list or edit the text.

Parameter	Setting
Severity	Set to the required alarm priority. This determines how the alarm is indicated. See details on page 52. If set to <i>Disabled</i> then the alarm will not activate.
Recognition Period	The alarm will activate only after the digital input is active for this period.
Deactivation Recognition Period	The alarm will deactivate only after the digital input is inactive for this period.
Digital Output Mapping A	If required, select a relay that will be operated when the alarm is active.
Digital Output Mapping B	If required, select a second relay that will be operated when the alarm is active.
Send Trap	Depending on this setting, an SNMP Trap will be sent for this alarm, on activation or deactivation or both, if the alarm's <i>Severity</i> matches the setting of

the SNMP Trap Level (see details on page 107).

Notes	Type any required description. When the alarm is active the text will be displayed on the SC300 and included in the SNMP trap (if used).
-------	--

Digital Outputs

The Input / Output (I/O) board is fitted with a number of digital outputs (relays) which can control external equipment or alarm systems. See Input / Output Board on page 2 for details.

Digital outputs are operated by a mapping from a digital input alarm (see details on page 86), an analog input high or low alarm (see details on page 82), or a system alarm (see details on page 52).

► To set the DO Control Timeout Period

- On DCTools/web, go to *Digital Outputs*:
 - Set DO Control Timeout Period to the required value. This sets the maximum time that a digital output will remain in manual control. After that time it reverts to automatic control.

► To manually control a digital output

Either:

- On DCTools/web, go to *Digital Outputs*:
 - Expand the *Digital Outputs* table.
 - In the *Control State* column of the required digital output, select *Active* or *Inactive*.
- Or, use the SC300 keypad to go to *Digital Outputs*:
 - Select the required digital output. Press *Edit*.
 - Select *Active* or *Inactive*. Press *Save*.
- The *DO Manual* alarm (if enabled) will activate.
- The corresponding digital output will Energize or De-Energize, as selected in the *Active State* column of the *Digital Outputs* table.

The digital output will revert to Automatic after the DO Control Timeout Period.

While Active or Inactive is selected, the DO will not be operated by any active alarms mapped to it. Set Control State back to Automatic to allow mapped alarms to operate the digital output.

► To set the state of a digital output from PowerManagerII

- In *Web*, set the *Group* of one or more digital outputs to a non-zero value.
 - Only digital outputs with a non-zero Group are visible in PowerManagerII*
- In *PowerManagerII* select the *SiteManager* group item.
- Click on the *Realtime* tab.
- From the drop down list beside the digital output select *Active Manual* or *Inactive Manual*.
- The *DO Manual* alarm (if enabled) will activate.
- The corresponding digital output will Energize or De-Energize, according to its *Active State*.
 - While Active Manual or Inactive Manual is selected, the DO will not be operated by any active alarms mapped to it. Set Control State back to Automatic to allow mapped alarms to operate the digital output.*

► To configure a digital output

- 1 On DCTools/web, go to *Digital Outputs*. Expand the *Digital Outputs* table.
- 2 Select a Digital Output. Refer to the I/O Board (IOBGP-xx) Connector Pin-outs on page 132 for IO Board output numbers.
 - ☐ *Other Digital Outputs will be available if additional I/O boards and/or SiteSure-3G modules are connected. See details in the dc power system Installation and Operation Guide.*
- 3 Configure the following parameters to suit the application.
 - ☐ *To change a setting, double-click and select from drop down list or edit the text.*

Parameter	Setting
Control State	Set to <i>Automatic</i> .
Status	Set to <i>Enabled</i> .
Name	Type the name of the output.
IOB Number	The number of the I/O board (or SiteSure-3G module). Do not change.
IOB DO Number	The number of the DO on the I/O board (or SiteSure-3G module). Do not change.
Active State	Select the state of the output when the DO is active*.
Group	Set to 0 unless using Groups in PowerManagerII. See PowerManagerII online help for details.

- 4 * One digital output is also used as the Monitor Fail alarm relay. Refer to the I/O Board (IOBGP-xx) Connector Pin-outs on page 132 for the output number. This output will de-energize if the I/O board loses power or loses communication with the SC300.

Alternative Energy Input Metering

The SC300 can meter currents supplied to the DC bus from alternative energy sources such as solar or wind. This means that it can calculate currents to and from the DC bus correctly, even when both rectifiers and alternative energy sources are providing power.

- ☐ *Currents from Eaton Solar Chargers (ASC48-ES) are automatically measured. It is not required to set up alternative energy input metering for ASC48-ES chargers.*

► To set up alternative energy input metering

- For each alternative energy source, connect a current sensor from the energy source to a current shunt input or analog input.
- On DCTools/web, go to: *Analog Inputs*.
- Configure the selected Analog Inputs and set *Function* to *Alternative Energy Source Current*.

The Alternative Source current is calculated as the sum of the currents of all analog inputs configured as *Alternative Energy Source Current*, plus the total current from all solar chargers controlled by the SC300.

Smart Alarms based on System Value Sources can be used to configure alarms based on the *Alternative Energy Source Current*.

See Smart Alarms on page 57 for details of how to set Smart Alarms.

- ☐ *The System Schematic shown in the SC300 web page displays the source current values (rectifiers and alternative energy sources) and load current values (load and batteries). If one of these values is not available, it is calculated from the other system current values. DCTools does not show solar / alternative energy sources on its system view, but the values are available in the analogue inputs page.*

Energy Metering

The SC300 can be configured with up to 20 energy meters.

Each energy meter can meter energy, power, minimum power, and maximum power.

The meters can measure load currents, alternative energy inputs, system values, and any other energy flow that can be connected to the SC300s through the IOBGP or IOBSS IO boards.

Power is calculated as voltage multiplied by current, except where power is directly measured by the solar charger, in which case that power value is used.

Energy is calculated as power continuously multiplied by time.

Several energy sources can be combined into a single meter. For example, this can be used to meter both individual loads and total load.

► To configure an Energy Meter

- 1 In *Meter Configuration > Meter Names*, enter the name of the meter.
- 2 Enter the input sources for the meter. These may be either Analog Inputs or System Value Inputs:

Analog Inputs

In *Meter Configuration > Analog Inputs*, enter the inputs for this meter:

- Meter number
- Analog input number for the energy source.
- Analog input function: current or voltage as appropriate.
 - If there is no analog input with Function = Voltage, the SC300 will use Bus Voltage for its calculations.
- To add more energy sources to the same meter, configure them as extra lines in *Meter Configuration > Analog Inputs*. The meter power and energy will be the total of all inputs mapped to the same meter.

System Value Inputs

The energy meter may also use the power, voltage, or current from a *System Value*.

- In *Meter Configuration > System Value Inputs*, enter the inputs for this meter.
 - For each input, set the System Input (and Index, where applicable).
 - If the System Value is a **power** value, this will be used directly as the meter power.
 - If the System Value is a **current** value, this will be multiplied by a voltage value mapped to the energy meter (or the Bus Voltage if there is no voltage mapped) to give the meter power.
 - If the System Value is a **voltage** value, a current value will also need to be mapped to the same meter (otherwise power will be measured as zero).
 - A System Value may be another energy meter. So it is possible to add two or more energy meters together to make a "Total Energy" meter.
- 3 If appropriate, enter *Power Gain* and *Offset* values for the meter.

► To reset an Energy Meter Power Minimum and Maximum values

In *Meter Configuration > Meters*, click on the appropriate reset button.

- Energy meter power minimum / maximum can be reset per meter, or all at once.

► To reset an Energy Meter Energy value

In *Meter Configuration > Meters*, click on *Reset all Energy Meters*.

Press enter to confirm you wish to reset all energy value.

- Energy values can only be reset all at once.

Information

The following information is available about energy metering.

Parameter	Description	Where to find:
Energy	The total energy in kWh measured by this meter. Energy continuously increases, except when manually reset.	
Current	The current used in calculating this energy meter power. <i>Current will show as zero if the power measurement comes directly from a system value (e.g. solar charger power).</i>	
Voltage	The voltage used in calculating this energy meter power.	SC300: Analog Inputs > right arrow > Energy Meter. Down arrow to select next energy meter if more than one.
Power	The energy meter power at present. This is calculated as Voltage * Current, except where it is directly measured by a solar charger or other device.	DCTools: Meters Web: Applications > Energy Metering > Meters
Power (Min)	The minimum power since the meter started, or the last time the power was reset.	
Power (Max)	The maximum power since the meter started, or the last time the power was reset.	
Meter Reset Date	The last time the meter power was reset. <i>13:00:00 01 Jan 70 <your current time zone> means that this meter has never been reset.</i>	

Configuration

Set the following parameters.

Parameter	Description	Where to find:
Name	User-specified energy meter name.	SC300: Not available.
Group	Set to 0.	DCTools: Meters Web: Applications > Energy Metering > Meter Names
Analog Input Meter Number	The meter that uses this analog input value.	SC300: Not available. DCTools: Meters
Analog input number	The analog input value that is used in this meter.	Web: Applications > Energy Metering > Meter
Function	Tells the SC300 whether to treat this value as a voltage (V), current (A), or power (W or kW) for the power calculation.	Configuration > Analog Inputs
System Value Meter Number	The meter that uses this system value.	SC300: Not available. DCTools: Meters
System Input	The System Value Input that is used in this meter.	Web: Applications > Energy Metering > Meter
Index	The System Value Index, where appropriate. <i>For instance, Power Meter 1</i>	Configuration > System Value Inputs

Power Gain	This is a scaling factor applied to the power input value. Use this where the input has to be multiplied by a constant value.	SC300: Not available. DCTools: Meters Web:
Power Offset	This is an offset applied to the power input value.	Applications > Energy Metering > Meters

Fan Controller

The SC300 can manage one FC100 Fan Controller module.

The FC100 can control up to 8 fans, with one or two independent proportional control modules.

For more information, see *FC100 Fan Controller Install and Operation*, available from Eaton.

The SC300 provides these features when used with the FC100:

- Configure primary and secondary control profiles for controller 1 and Controller 2.
- Set fan controller mode.
- Switch from primary to Secondary control profiles by Smart Alarm control
- Manual speed control over-ride.
- View temperature inputs
- View fan speeds
- Report fan controller alarms and values remotely.

► To connect a Fan Controller

The FC100 fan controller is an RXP device and must be registered with the SC300 before it will communicate with it.

- 1 Connect the FC100 communications port (RJ-45) to the RXP bus using an RJ-45 patch cable.
 - Generally, there will be a spare RXP connection on the VFN board.*
- 2 In web, go to *System > Interfaces > RXP*.
- 3 In DCTools, go to *Configuration > RXP*.
- 4 The RXP Devices table should show the FC100.
- 5 Copy the FC100 serial number into the next available position in the IO Board to Serial Number Mapping table.
- 6 Click on *Apply Changes*.

► To configure a Control Profile

The control profile specifies how fan control power percentage (and hence speed) varies with temperature.

It consists of six temperature / power settings. The FC100 will smoothly increase fan speed as temperature increases from one point to the next.

The control profile will be pre-determined according to the enclosure and fan characteristics. Unauthorized changes could cause over-heating.

- 7 Select the required profile to enter.
 - Generally, this will be Controller 1, Primary Profile.*
- 8 Enter and apply values for all six temperature / power pairs.

► To set fan controller mode

Set *Mode* to any of these values:

Single Controller

All fans are driven from temperature sensor 1 and controller 1 profile.

Dual Controller

Temperature sensor 1 drives both controllers with their own profiles.

Independent Controller

The two controllers work independently with their own temperature sensors.

► To change profile by Smart Alarm

For example, use a Smart Alarm schedule to set a different control profile at night.

- 1 Configure a Smart Alarm as required. When this Smart Alarm is active, the fan controllers will change from using Primary Profiles to using Secondary Profiles.
- 2 Set Secondary Profile Activating Smart Alarm to the Smart Alarm number.

► To manually control the fans

The fans can be run under manual control for testing. They will revert back to automatic control after the time set by Fan Voltage Period.

Set Fan Power as required. Range is 0 to 100%.

Set Fan Power Period to the required value.

Click on Force to run the fans at the required manual power setting.

Information

The following information is available about the fan controller:

Parameter	Description	Where to find:
Temperature	The temperature measured by each fan controller temperature sensor.	SC300: Not available
Fan Power	The percentage of full power the fan is set to.	DCTools: Fan Controller > State
Mode	The FC100 operating mode	Web: Applications > Fan Controller > State
Status	"-" if the FC100 is running normally, otherwise any active fan controller alarms.	
Running Profile	The control profile currently in use.	

Configuration

Set the following parameters.

Parameter	Description	Where to find:
Set Fan Power	Manually set the fan control power.	SC300: Not available. DCTools: Fan Controller > Manual Speed Control Web: Applications > Fan Controller > Manual Speed Control
Mode	The fan controller mode. <i>See details above.</i>	SC300: Not available.
Secondary Profile Smart Alarm	When this Smart Alarm activates, it will cause the FC100 to change from Primary Secondary control profile. Zero means no Smart Alarm control.	DCTools: Fan Controller > Configuration Web:

Temperature / Power	The temperature / power pairs specify how the fan speed changes with temperature for each control profile.	Applications > Fan Controller > Configuration
---------------------	--	---

Data Logging

The SC300 has the following data logging functions.

All log files are readable by Excel or similar spreadsheet programs.

- When opening a log file, Excel gives the message "The file you are trying to open, ..., is in a different format than specified by the file extension. Verify that the file is not corrupted and is from a trusted source before opening the file. Do you want to open the file now?". Click Yes.*
- The SC300 has several combined log files. These include a large amount of data, and will take significantly longer to download than a single log.*
- All logs can be downloaded using web. However, DCTools can only download the Event, Data and Energy Logs.*

Event Log

The Event Log records every system event. See System Event Types on page 137 for a description of event log entries.

Data Log

The Data Log records several system parameters (AC Voltage, Bus Voltage, Load Current, Rectifier Current, Battery Current, Battery Temperature and Ah Discharged) at specified intervals. The rate of recording increases (interval is reduced) when the bus voltage differs from the float voltage by more than a specified value.

Data log entries are also written whenever a system event occurs (as for the Event Log).

Data Min/Max Log

This log records the minimum and maximum values of the logged inputs during each log interval.

Data and Events Log

This log shows data and events in a single log file. This is useful for fault -finding, as it shows alarms and analog values on the same time scale.

Energy Log

The Energy Log records the energy reading for all configured energy meters at the specified Energy Meters Log Interval.

Power Log

The Energy Log records the power reading for energy meters at the specified Power Meters Log Interval. It includes for each interval:

- Power
- Power Minimum
- Power Maximum

All Meters Log

The Meters Log is a combination of the Energy Log and Power Log. It includes all records from both these logs.

Smart Analogues Log

The Energy Log records the values of all configured Smart Analogues at the configured Smart Analogues Log Interval.

 To log *any* analog input, simply configure a Smart Analog mapped to the required input.

Smart Analogues Min/Max Log

This log records the minimum and maximum values of the logged inputs during each log interval.

Generator Log

This records the fuel level, fuel refill and generator state at the specified Generator Log Interval.

Fan Controller Log

This logs data from an FC100 Fan Controller logger option.

Battery Symmetry Monitoring Log

This logs battery mid and quarter point voltages.

All Logs

This log combines all the above logs into a single file.

 This log file may be large and slow to download.

 If the various log intervals are different, there may be a large number of blank entries.

Audit log

This log provides a history of logins and other security-related events. This is in text form.

Raw log binary

This log is included for future use.

► To download a log using Web

Go to *Logs > Download* and click on *Download* next to the required log.

Wait for the log entries to download from the SC300.

After the download finishes, Excel gives the message “The file you are trying to open, ..., is in a different format than specified by the file extension. Verify that the file is not corrupted and is from a trusted source before opening the file. Do you want to open the file now?”.

Click *Yes*.

► To download a log using DCTools

Go to *Event Log, Data Log or Energy Log*. Downloading will start immediately.

When downloading finishes, click on *Save to File*.

Type a file name, select a file type, and browse to a location to save the file.

Excel gives the message “The file you are trying to open, ..., is in a different format than specified by the file extension. Verify that the file is not corrupted and is from a trusted source before opening the file. Do you want to open the file now?”.

Click *Yes*.

► **To clear all logs**

In Web go to *Logs > Download*.
 In DCTools, go to *Controller Log > Configuration*.
 Click *Clear Logs*.
 This will clear all log data.

► **To configure the Data Log using Web or DCTools**

Go to *Logs > Log Configuration*.
 Check and set the following parameters:

Parameter	Description	Where to find:
Log Interval for each log type	The time between each log record. This log interval applies when logging is at normal speed. When logging is at off-normal, and <i>Use Off Normal</i> is selected for a log, it records at <i>Off-Normal Interval</i> .	
Use Off Normal for each log type	If this item is selected, the log records at Off-Normal Interval when in off normal condition.	Web: Logs > Configuration
Off Normal Interval	In off normal condition, all logs record at this interval.	DCTools : Logs > Configuration
Off-Normal Smart Alarm	Use this to configure the SC300 to log at the off-normal rate when a Smart Alarm is active.	
Off-Normal Offset Voltage	<i>Off-Normal Interval</i> will apply when bus voltage is outside the range: <i>Float Voltage ± Off-Normal Offset Voltage</i> . Off-normal condition transitions are recognized within 10 seconds.	

Log Storage

The SC300 logs all share a common memory space. When this log is full, the earliest log records are deleted to make room for new records.

Each log type occupies a different amount of memory:

- Data log consumes the most space
- Event log consumes very little space
- Other logs are in between.

Log Configuration			
	Log Interval	Use Off Normal	Entries
Smart Analogs	30m	-	0
Generator Control	30m	-	0
Energy Meters	30m	-	0
Power Meters	30m	-	0
Other Meters	30m	-	0
Fan Controller	30m	-	6
Data	10m	✓	16
Battery Symmetry Monitoring	30m	-	0
Off-Normal Interval	1m		
Off-Normal Smart Alarm	0		
Off-Normal Offset Voltage	4.00 V		
Off-Normal	-		
Months Covered by Log	2		
Current log file size	3166		

With a typical setting of 30 minutes interval between all log records, and no alarms, the log will fill in about 3 years.

With data logging set to 1 minute, the log will fill in about 1 month. To avoid losing data, it would be necessary to download and save the logs at intervals less than one month.

The SC300 estimates the time to fill the log and displays it on the web under Log Management.

 *These estimates assume no alarms are active, and no Smart Analogs, Generator or Fan Controller are configured. These will add data and reduce the time to fill the logs.*

Set the log intervals for the required time resolution, bearing in mind the time to fill the logs.

Standby Mode

Two SC300s may be connected in the same power system to the same RXP bus.

One of the SC300s will operate as normal (Active SC300) and the other will act as a backup unit (Standby SC300).

If the Active SC300 fails or is removed, then the Standby SC300 will become Active after two to three minutes, and then control the power system in the usual way.

The *Standby Mode* alarm indicates that an SC300 is or has been in Standby mode.

When a standby unit is present, the Active SC300 will show an *Unknown Hardware* alarm.



Configuration

Ensure that both Active and Standby SC300s have identical configuration settings, except for *Standby Mode at Startup*, *IP address* and *Identity* settings.

It is recommended that *Site Name* be used to distinguish between the normally Active and Standby SC300s. For instance, "Site A Active" and "Site A Standby".

► To Test Standby Mode operation

- Start the system as normal.
- Remove power on the Active SC300, or reset it using the web or front panel.
- After 1 minute or less, the Standby SC300 should become Active.

► To reset the Standby Mode alarm

Go to *Alarms* and press *Reset Standby Mode* alarm.

On the front panel, select the alarm and press *Clear*.

Configuration

► To configure two SC300s to work in Standby mode

- Configure both SC300s with the same settings, except for identity and address settings.
- Connect both SC300s to the system RXP bus.

Normally this is done by connecting both back to the VFN board using an RJ-45 patch cable.

- Choose which SC300 is to be the Standby unit.
- Set *Standby Mode at Startup* for this unit to *Yes*.

This only affects operation when both SC300s start at the same time; the SC300 configured to *Start in Standby Mode* will delay start-up and allow the other SC300 to start in *Active mode*.

Parameter	Description	Where to find:
Standby Mode at Startup	This setting tells the SC300 to startup in Standby mode if it is starting at the same time as the other SC300. It will not affect operation otherwise.	SC300: Setup Web: System > Interfaces> Standby Mode
Reset Standby Mode Alarm	Resets this alarm.	SC300: Alarms > Standby Alarm DCTools/Web: Alarms

DC/DC control

 *Contact Eaton for details on DC/DC converter control.*

A/B systems

 *Contact Eaton for details on A/B system control.*

Overview

Topic	Page
Communications Options	101
Direct (USB) Communications	101
Ethernet Communications	101
Serial (RS-232) Communications	111
Communications Security	114
CSP	116

Communications Options

The SC300 system controller has a type AB Micro-USB interface, an RS-232c serial, and an Ethernet 100BaseT interface (XS31) for communication with a local or remote PC or laptop, or a Network Management System (NMS). See the diagrams on page 1 for locations of these connectors.

The standard communications options for an SC300 system controller are described in the following sections. For other communications options contact your Eaton dc product supplier or see Worldwide Support on page 159.

Direct (USB) Communications

See SC300 Operation Using a PC/Laptop on page 14.

Ethernet Communications

Connections

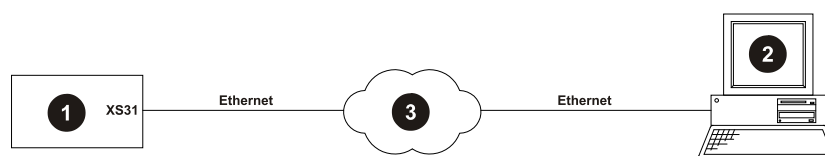

1. SC300 system controller
2. PC/laptop with:
 - PowerManagerII / PowerManager3 (see details on page 104), and/or
 - DCTools, and/or
 - Web browser (see details on page 104), and/or
 - Network Management System using SNMP (see details on page 105), and/or
 - Building management System using Modbus-TCP (see details on page 109).
3. Communications network. Protocol: TCP/IP, IPV4 or IPV6.

MAC Address

► To view the MAC Address of the SC300

Either:

- Use the SC300 keypad to go to: *Info*

Or:

- With DCTools/web , go to *System > Interfaces> Physical Ports > Ethernet*

 *The Media Access Control (MAC) address is the SC300's unique Ethernet address assigned by the manufacturer.*

SC300 Setup

 *The network administrator may assign a unique IP address to each SC300 to be connected to the TCP/IP network.*

 *Alternatively, use DHCP or Auto IP to automatically assign an IP address. However, if the SC300 is being managed by PowerManagerII or PowerManager3, or some other NMS, a fixed IP address is recommended.*

► To configure an SC300 for IPV4 Ethernet communications from the keypad

- Go to *Settings > Setup*
- Enter the *IP Address, Subnet Mask* and *Gateway Address* assigned by the network administrator.
- If *IP Address, Subnet Mask* and *Gateway Address* are both left at 0.0.0.0, the SC300 will automatically be assigned an IP address using DHCP or Auto IP.
- If required, set *Web Access* to *http only* or *http and https*.

 *Default web access is https only. This is the most secure option and should be used where possible.*

► To configure an SC300 for IPV4 Ethernet communications using USB

- Ensure DCTools is installed.

 *It is necessary to update DCTools for operation with SC300.*

- Connect using USB (see details on page 14).
- DCTools should open automatically and show the SC300 view. If not, open a new connection in *Connection Manager*, and at *Connect Using*, select the appropriate comm port. This will be a new serial port number that appears when the SC300 is connected.
- Go to *Configuration > Communications > Ethernet*.
- Set *IP Address Config, Subnet Mask Config* and *Gateway Address Config* as assigned by the network administrator.
- If *IP Address Config, Subnet Mask Config* and *Gateway Address Config* are all left at 0.0.0.0, and

AutoIP is set to Enabled, the SC300 will automatically be assigned an IP address using DHCP or Auto IP.

- If required, under *Ethernet* set *Web Access* to *http and https* or *http only* for unsecured web browser access.

▶ **To view the IP V4 address using web**

- Go to *System > Interfaces > Ethernet Auto*.
- This section shows the current IP address settings, whether they are set manually or by DHCP / Auto IP.

▶ **To manually change IP V4 settings using web**

- Go to *System > Interfaces > Ethernet*.
- Set *IP Address*, *Netmask*, and *Gateway Address* as required.

If the IP address is changed, the web connection will stop working until the browser is set to the new IP address.

▶ **To configure the SC300 for IPV6**

With IPV6, it is not usually necessary to assign an IP address. The SC300 will be assigned a unique IPV6 address based on the MAC address.

The SC300 will automatically detect when it is connected to an IPV6 network.

- Go to *System > Interfaces > Ethernet*.
- Ensure *IP Address*, *Netmask*, and *Gateway Address* are all set to defaults (0.0.0.0).
- Ensure *Auto IP* is set to *Enabled*.

▶ **To connect directly from computer to SC300 using Ethernet / AutoIP**

This is an alternative to USB and DCTools. Use this if it is needed to use web connection without the SC300 connected to a network.

- From the front panel, go down to *Settings* and press *Enter*.
- Check that *Addr.*, *Mask*, and *Gateway* are all set to 0.0.0.0
- Check that *AutoIP* is set to *Enabled*.
- Connect from the computer to SC300 with a normal Ethernet cable.
- The SC300 and computer will negotiate IP addresses.
- On the front panel, press *i*.
- Check the IP address (shown as "IP:").
- Open a web browser and browse to this IP address.

The SC300 defaults to https only.

PowerManagerII Communications Setup (if required)

 *PowerManagerII supports only features provided by SC200. New features provided by the SC300 are not shown in PowerManagerII.*

► **To connect to the SC300 with PowerManagerII:**

- 1 Install PowerManagerII on the PC/laptop.
- 2 An additional interface file may be needed. Contact your Eaton representative for details.
- 3 Double-click the PowerManagerII icon to open the connection manager.
- 4 Go to *Connection > New* to open a new connection dialog box.
- 5 Enter:

Connection Name:	<as required>
Comms Enabled:	True
Protocol:	S3P
Connect Using:	Ethernet
S3P Address:	0 (0 = Broadcast, 1-65279 = individual address)
Server IP Address:	Allocated by network administrator
Server Port:	Allocated by network administrator
Telnet	Cleared

- 6 Press OK. PowerManagerII will now connect to the SC300.
- 7 If required, access to the SC300 via PowerManagerII can be password controlled. See Write Access Password on page 114.

Communication via Web Browser

The SC300 system controller has an in-built web server. This allows a PC/laptop with a standard web browser to control and monitor the SC300 via an IP network.



Web security

The SC300 is supplied with the following default user name and password:

User name "SC300"



Password "Factory300".

Use these for the first web login to the SC300.

A blank user name and password are not accepted.

To ensure secure operation, this password should be changed after first login to a secure new user name and password. Ensure that network administrators are aware of the new user name and password.

► **To connect to the SC300 with web browser:**

- 1 Set up Ethernet communications and connect the SC300 to the IP network. See Ethernet Communications on page 101.
- 2 Open a web browser window.
 -  *Recommended web browsers: Microsoft Edge, Mozilla Firefox 3.0 or later, Chrome V63 or later.*
 -  *Internet Explorer 10/11: Ensure that Compatibility Mode is turned off. Go to Tools >*

Compatibility View Settings.

- 3 Type the IP Address of the SC300 into the address bar of the browser.
 - SC300 web communications is set by default to http disabled and https enabled.
- 4 If https is being used, and this is the first connection to that SC300, the browser may ask whether you to “confirm a security exception”, or similar. You will need to add an exception, accept the certificate. and then continue. The exact details will depend on the browser.
- 5 The SC300 web server Log On page will appear.
- 6 The default language is English. To change the web language, select the language drop down on the right and select the appropriate language.
 - Some language translations are incomplete in SC300 software version 1.14.
- 7 Type a Logon ID and Password.
 - See the warning above if this is the first logon.
 - Administration of Logon IDs and Passwords is available in Web. See Web Access Security on page 115.
- 8 Click Log On. The SC300 web system page will be displayed.
- 9 Click on the appropriate menu item on the left.
- 10 To change a setting double click the text field, type the new value, then press Enter on the PC keyboard. Then click Apply in the Changes window.
 - Hold the mouse pointer over any field for help.
- 11 Click Log Off (top right of window) to log out.

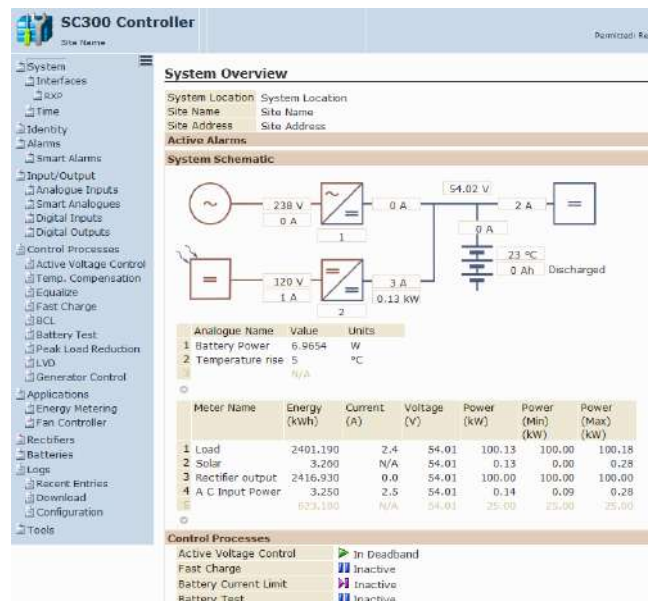
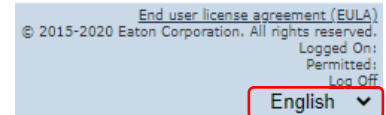

Communication via a Network Management System using SNMP

The SC300 system controller can be configured to allow access by a Network Management System (NMS), and/or to send alarms as SNMP traps to up to eight different SNMP trap receivers on an NMS.

► To download the SNMP MIB file

 This feature is not available in DCTools.

- 1 In the web view, go to Tools.
- 2 Right click on *SNMP V2/V3 SNMP MIB* [Download](#).

► To allow SNMP access to the SC300

 Note: for SNMP V3 access, see [To communicate using SNMP V3 on page 106](#).

- 1 Set up Ethernet Communications (see details on page 101).
- 2 On the web, go to *System > Interfaces > Remote Access Protocols > SNMP*.
- 3 In DCTools, go to *Communications > Remote Access Protocols > SNMP*
- 4 Set the following parameters:

SNMP Access:	<p>Disabled: NMS access to the SC300 is not allowed.</p> <p>All: the NMS has full access to the SC300.</p> <p>Read Only: the NMS has read only access to the SC300.</p> <p>V3 Only: only SNMP v3 access is allowed.</p>
Read Community	The default read community is EatonPublic.
Write Community	The default read community is EatonPrivate.
	<p> Many network management systems default to read community = public, and write community = private.</p>
V3 Privacy Password	Only used with SNMP v3 and if an authentication password is set. This password is needed only if the NMS uses encryption.

To communicate using SNMP V3

► Complete the steps in *To allow SNMP access to the SC300*

Then:

- 1 In web, go to *System > Interfaces > Users*.
- 2 Expand the table to the right.
- 3 Select an existing user to configure for SNMP V3 access, or create a new user.
- 4 Set the following parameters for each SNMP V3 user:

logon ID	Ensure the logon ID matches the SNMP V3 user name.
Password	Set this to the SNMP V3 authentication password.
SNMP V3	Set to the appropriate SNMP V3 access rights for this user.

 The SC300 uses:

- SHA authentication protocol
- AES128 privacy protocol
- Context name is blank (not used).

To send alarms as SNMP traps

- 1 Set up Ethernet Communications (see details on page 101).
- 2 In web go to *System > Interfaces > Remote Access Protocols > SNMP*.
- 3 In DCTools, go to *Communications > Remote Access Protocols > SNMP*
- 4 Set the following parameters:

Trap Version:	Set to <i>SNMP V2</i> or <i>V3</i> as required.
Trap Format:	Set to <i>Eaton</i> or <i>X.733</i> as appropriate . <i>X.733</i> format uses a single trap number for all alarm sources. "Eaton" format uses different trap numbers according to the alarm source. <input type="checkbox"/> <i>X.733 is the default and is recommended for most applications.</i>
Enable Generic Traps	If enabled, the SC300 will send traps on system events such as restart.
Trap Repeat	Enable trap repeat if the network is not reliable enough to ensure that traps get through the first time.
Trap Repeat Rate	
Enable Heartbeat Trap	The heartbeat trap (if enabled) is sent periodically to tell the NMS that the SC300 is still "alive" and communicating.
Heartbeat Trap Period	

For each SNMP trap receiver (up to 8), configure the following parameters:

Parameter	Configuration Guidelines
Name	Type the name of the SNMP trap receiver (20 bytes maximum). <input type="checkbox"/> <i>This allows 20 ASCII characters, but less for languages with multi-byte characters.</i>
Level	SNMP Trap Level – controls reporting of specific events for each receiver: <ul style="list-style-type: none"> • Select All Alarms And Warnings to receive Critical, Major and Minor alarms, and Warnings. (Typically Warnings are status messages such as Equalize Active.) • Select Minor And Above to receive Critical, Major and Minor alarms. • Select Major And Above to receive only Critical and Major alarms. • Select Critical Only to receive only Critical alarms. • Select Disabled to disable notifications to the receiver. <input type="checkbox"/> <i>To prevent an SNMP Trap for an individual alarm, set Send Trap to False in the alarm's configuration.</i>
IP Address	IP address of the trap receiver assigned by the network administrator.
Port	The default setting is 162. Do not change this setting, unless requested by the network administrator.
Trap Community	A form of password used with SNMP V2c. The SC300 default is <i>EatonPublic</i> .

- | | |
|------|---------|
| Mode | Select: |
|------|---------|
- **Normal Traps** for sending traps to any network management system, except *PowerManagerII*
 - **Acknowledged Summary Trap** for sending traps to *PowerManagerII* only

To change SNMP trap sending options by trap source

To make the SC300 send a trap only on an alarm activation or deactivation, or to stop the SC300 sending any traps when a particular alarm occurs:

- 1 Go to the *Send Trap* setting for that particular alarm. *Send trap* settings are present in the Alarm States Table, Analog Input Alarms tables, and Digital input alarms table.
- 2 Change the setting from *Both* to :
 - *None* for no traps sent for that alarm
 - *Activation*, for traps sent only when the alarm becomes active.
 - *Deactivation*, for traps sent only when the alarm becomes inactive.

Communication via email

The SC300 system controller can be configured to send Email alarm messages when an alarm is activated or de-activated.

► **To set up email communications:**

- 1 Set up Ethernet communications and connect the SC300 to the IP network. See Ethernet Communications on page 101.
- 2 On the web, go to *System > Interfaces > Remote Access Protocols > Email Notifications*.
- 3 In DCTools, go to *Communication > Remote Access Protocols > Email Notifications*.
- 4 Enable *Email Notifications*.
- 5 Set the following parameters:

SMTP Server IP Address and Port:	The details of the mail server that will be used to send the Emails.
Valid address:	This is an address needed for logging purposes by some email servers. Leave this empty unless the email server specifically requires a valid address.
From Address:	The address the email comes from. The default is: <i>Site name@System location@ Site address</i>
Return Address:	The return address for the email. The default is: <i>donotreply@ invalid domain</i>
Subject Prefix:	An optional email subject prefix that will be added to each email's subject to allow automatic processing of the email.

- 6 For each Email recipient (up to 6), set the following parameters:

Address:	The recipient's email address.
----------	--------------------------------

Level:	<p>The severity of alarms that are to be reported to this recipient.</p> <ul style="list-style-type: none"> • Select <i>Warnings And Above</i> to send an email when an alarm with a severity of <i>Warning</i> or above changes state. • Select <i>Minor And Above</i> to send an email when an alarm with a severity of <i>Minor</i> or above changes state. • Select <i>Major And Above</i> to send an email when an alarm with a severity of <i>Major</i> or above changes state. • Select <i>None</i> to send no emails. • Select <i>Critical Only</i> to send an email when an alarm with a severity of <i>Critical</i> changes state.
Delay:	<p>The alarm Email will be delayed by this length of time. During this delay, the SC300 will collate all the events that occur into a single email.</p>

Test Emails can be sent to test the Email Communication setup.

► **To send a test Email:**

- 1 On the web, go to *System > Interfaces > Remote Access Protocols > Email Notifications*.
- 2 In DCTools, go to *Communications > Remote Access Protocols > Email Notifications*.
- 3 Click the *Send Test Email* button on the row of the Email address to be tested.

► **Diagnostics**

- 1 On the web, go to *System > Interfaces > Remote Access Protocols > Email Notifications*.
- 2 In DCTools, go to *Communications > Remote Access Protocols > Email Notifications*.
- 3 The result of the most recent SMTP operation affecting each recipient is shown on the row containing the recipient's Email address.

The first digit shows the progress of the email. "6" means the email was sent successfully. Smaller numbers mean partial delivery. The last three digits represent the SMTP reply codes.

Examples include:

250 (OK), 220, 221, 354, 421 and 450 (Service unavailable/no permission, detected spam or destination unreachable), 451, 452, 455 (Server memory issue), 500-503 (Controller conversation not correct), 521 (Service broken), 541, 550-554 (Spam detected), 9888 Unexpected State and 9999 Connection issue.²

Modbus-TCP Communications

The SC300 can be configured to accept Modbus queries and commands from a Modbus Building Management System or other Modbus master.

► **To download the Modbus register map**

 This feature is not available in DCTools.

- 1 In the web view, go to Tools.
- 2 Click on *Modbus Register Map (xlsx)* [Download](#).

² Web search "RFC1821" for more error code details.

Modbus-TCP* Connections

 The SC300 V1.14 and later versions can accept several simultaneous Modbus connections.

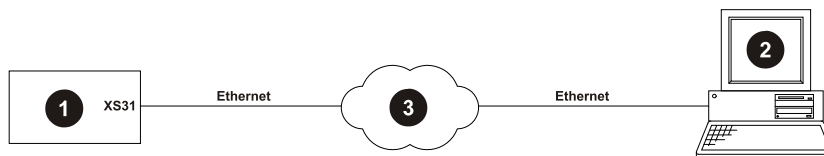

- 1. SC300 system controller
- 2. PC/laptop with Building Management System using Modbus-TCP.
- 3. Communications network. Protocol: TCP/IP

SC300 Setup

- 1 Setup Ethernet Communications (see details on page 101).
- 2 Set the following Modbus-TCP* parameters:

Parameter	Description	Where to find:
Modbus Access	Set to <i>Enabled</i> .	SC300: Settings > Modbus
Address	Set to 1 for Modbus-TCP.	Web: System > Interfaces > Remote Access Protocols > Modbus DCTools: Communications > Remote Access Protocols > Modbus
Modbus White List	To restrict access to approved Modbus masters, enter the IP addresses of the masters here. If no addresses have been added, there is no restriction.	

 * The SC300 also supports Modbus-RTU via the RS-232c serial port (XS1). For details request Application Note AN0149 from your Eaton dc product supplier.

Diagnostics

The following diagnostic information is available.

Parameter	Description	Where to find:
Bus Message Count	Number of messages. Does not include messages with bad CRC.	
Bus Communication Error Count	Number of CRC errors.	
Slave Exception Error Count	Number of exception errors.	Web: System > Interfaces > Remote Access Protocols > Modbus > Diagnostics
Slave Message Count	Number of messages to the SC300.	
Slave No Response Count	Number of messages received for which no response was sent.	

Bus Character Overrun Count Number of messages received with more than 256 characters.

 All counts are since the last SC300 restart or since counter was reset.

Serial (RS-232) Communications

The parameters of the RS-232 serial port can be configured, if required, for a specific RS-232 device. However, for most applications use the default settings.

Parameter	Description	Where to find:
Baud Rate	Default: 19200	SC300: Settings > Serial Port Settings
Parity	Default: None	Web: System > Interfaces > Physical Ports > Serial > Port Settings
Stop Bits	Default: One	DCTools : Communications > Physical Ports > Serial > Port Settings

GSM Modem Communications

A GSM modem may be added allow the SC300 to send SMS alarm messages.

Connections

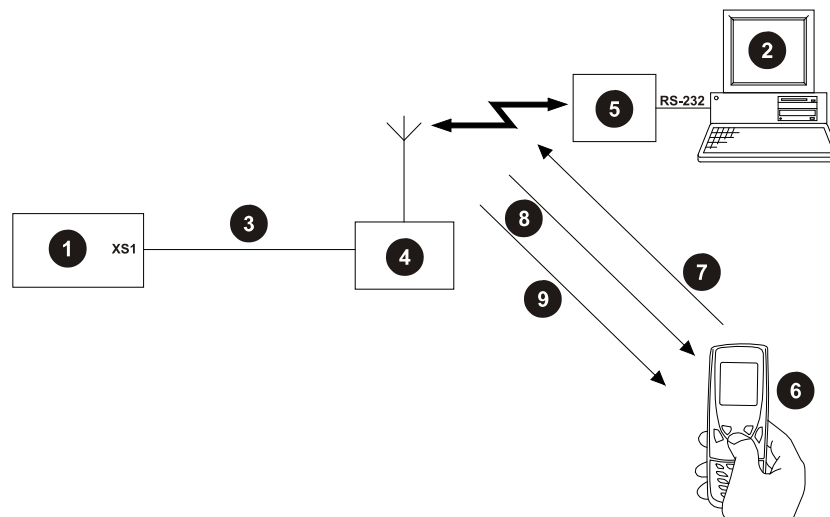

1. SC300 system controller
2. PC/laptop with web browser and SC300 web driver
3. RS-232 modem cable (straight-thru). If access to XS1 is restricted use a DB9 ribbon cable extension (Farnell part number 869-6411).
4. GSM modem
5. Optional:PC modem
6. SMS text capable GSM cell phone or SMS-Email Gateway (if available)
7. SMS text message "P" or "p"
8. Power status text messages
9. Alarm text messages

SC300 Setup

 Not all modems are suitable. If your modem does not operate correctly check the modem setup string. Contact your Eaton dc product supplier or Eaton for further assistance. See *Worldwide Support* on page 159.

► To enable modem communications



- 1 Connect to the SC300:
- 2 On web, go *Interfaces > Physical Ports > Serial*.
- 3 In DCTools, go to *Communications > Physical Ports > Serial > Modem*.
- 4 Click on + to expand **Serial**. Configure the following settings:

Enable Modem:	Enabled
Modem Power Reset:	Optional. If this is enabled, then the SC300 will attempt to reset a non-operating modem by turning its power supply off and on using digital output 2.
Modem Set Up String:	The string sent to the modem on reset. The modem AT command should not be included as it is automatically sent. The Auto-Answer Rings parameter is also sent, so it does not need to be included here. For complete details of appropriate commands, consult your modem documentation.
Modem Auto Answer Rings:	Number of rings before an incoming call is answered. Setting this parameter to zero disables incoming calls (the modem can still be used for alarm reporting).

SMS Text Messaging Setup

 For additional information see *Application Note AN0112*. To receive application notes, see *Worldwide Support* on page 159.

► To enable SMS alarm messages

- 1 On web, go to *System > Interfaces > Physical Ports > Serial > SMS Notifications*.
- 2 In DCTools, go to *Communications > Physical Ports > Serial > Modem > SMS Notifications*.
- 3 For each cellphone to receive SMS alarm messages set the *Phone Number* and other details as required.
- 4 Type the required *Prefix* string if alarm messages are to be sent to an email address.
 -  This requires a GSM-Email Gateway connected to the GSM network. Contact the GSM network operator for details of the *Prefix* string required at the beginning of the SMS message.
 -  Emails can also be sent via an IP network. See details on page 108.

► To check the dc power system status using SMS

- 1 From any cellphone write a SMS (text) message starting with "P" or "p" (any following characters are ignored).
- 2 Send the message to the SC300 GSM modem telephone number.

The SC300 will reply with a dc power system status message. This will include: Number of active alarms, bus voltage, load current, ac voltage, battery current, battery temperature, battery time remaining (if available).

Serial Server

The SC300's Serial Server function makes the SC300's RS-232 port available to any software via Ethernet.

For example, use Serial Server to connect Winpower to a Matrix Controller connected to the SC300.

 For details request AN0117, *Communicate with Matrix Controllers through an SC200*, from your Eaton dc product supplier. Details in this AN also apply to SC300.

Connections

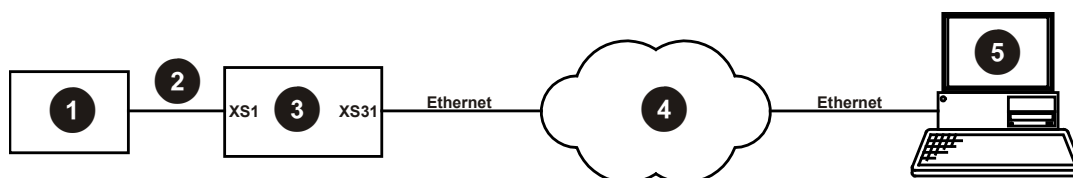

- | | |
|--|--|
| <p>1) External device.</p> <p>2) RS-232 modem cable. For the SC300's RS-232 port, see details on page 131. For details of the external device's RS-232 port and whether the cable should be straight-through or crossed (null modem), see the external device's documentation.</p> | <p>3) SC300 system controller.</p> <p>4) Communications network. Protocol TCP/IP.</p> <p>5) PC/laptop with PowerManagerII, or other software with a port redirector.</p> |
|--|--|

► SC300 Setup

- 1 Configure the SC300 for Ethernet communications. See details on page 101.
- 2 Either:
 - On the SC300 keypad go to *Settings > Setup > Serial Server*. Select *Enabled*.
 - Or:
 - Use Web to go to *System > Interfaces > Remote Access Protocols > Serial Server*, or
 - In DCTools, go to *Communication > Interfaces > Remote Access Protocols > Serial Server*
 - Set *Access* to *Enabled*.

PowerManagerII Setup

 Use similar settings for other software.

- 1 Install PowerManagerII on the PC/laptop.
- 2 Double-click the PowerManagerII icon to open the connection manager.
- 3 Go to *Connection > New* to open a new connection dialog box.
- 4 Enter:

Connection Name:	<as required>
Comms Enabled:	True
Protocol:	S3P
Connect Using:	Local Network
S3P Address:	0 (0 = Broadcast, 1-65279 = individual address)
Server IP Address:	The IP Address of the SC300. Allocated by network administrator.
Server Port:	15000

Telnet Cleared

- 5 Press OK. PowerManagerII will now connect to the device connected to the SC300's RS-232 port.

Communications Security



SC300 settings cannot be changed if:

- All communications are disabled (see SMNP Communications on page 106, and HTTP/HTTPS Access on page 115), and
- Keypad access (see details on page 12) is *Read Only*, or PIN Protected and the keypad access PIN is lost.

In this situation the SC300 will continue to function, but no configuration changes can be made. Contact your Eaton dc product supplier or Eaton for advice (see Worldwide Support on page 159).

Serial Communications (USB / RS-232) Security

S3P Access

S3P is the serial communications protocol used by the SC300 to communicate with *PowerManagerII* via the USB, RS-232 or Ethernet port.

 *S3P Protocol is not used by the web server.*

► To Enable/Disable S3P access

- On the SC300 keypad go to *Settings > Setup > S3P*. Select *Enabled* or *Disabled*.

Or:

- 1 Connect to the SC300 (see details on page 101).
 - Web: go to *System > Interfaces > Remote Access Protocols > S3P*.
 - DCTools: go to *Configuration > Communications > Remote Access Protocols > S3P*.
- 2 Set *Access* to *Enabled* or *Disabled*.

Write Access Password

The Write Access Password prevents unauthorized changes to the SC300 configuration (using *PowerManagerII*).

 *When a Write Access Password is set serial communications access to the SC300 (using *PowerManagerII*) is read only. The password must be entered before any setting can be changed.*

 *If a Write Access Password is lost, clear it from the SC300 keypad and change it via the Web.*

► To set a Write Access Password

- 1 Connect to the SC300 with Web (see details on page 101).
 - Web: go to *System > Interfaces > Remote Access Protocols > S3P*.
 - DCTools: go to *Configuration > Communications > Remote Access Protocols > S3P*.
- 2 Type a password into the *Write Access Password* field.
 -  *Passwords are case sensitive, maximum 32 characters.*
- 3 Click the *Apply Changes* button.

► To clear or change a Write Access Password

- 1 Connect to the SC300:
 - Web: go to *System > Interfaces > Remote Access Protocols > S3P*.
 - DCTools: go to *Configuration > Communications > Remote Access Protocols > S3P*.
- 2 Type a new password into the *Write Access Password* field or leave the field blank for no password control.
- 3 Click the *Apply Changes* button.

► **To clear a Write Access Password from the SC300**

- 1 Use SC300 keypad to go to *Settings > Setup > Clear Write Access Password*
 - This option only appears if a Write Access Password is set.*
- 2 Press *Enter*.
 - The password is now permanently cleared. If required, reset the password with Web or DCTools.*
 - If you are connected with DCTools, disconnect and reconnect. You will then be able to save items.*

Web Access Security

Server Access

Access to the SC300 web server is set by default to https only.

Access can be changed to allow http access if necessary.



http access is insecure. It is not recommended to use http in any network that does not have restricted access.

► **To change access to the web server**

Set the following parameters as required.

Parameter	Description	Where to find:
Web Access	Leave at https only, or set to http only (not recommended) or http/https.	SC300: Settings > Setup DCTools: Configuration > Communications > Remote Access Protocols > HTTP (Web) Web: System > Interfaces > Ethernet

User Setup

► **To setup specific users and control their access levels**

For each user, set the following parameters as required.

- If there are no active users then web access is disabled.*

Parameter	Description	Where to find:
-----------	-------------	----------------

User Name	This is not used in the login process (except for "Default User"). It is displayed at the top-right of the Web view screen.	
Logon ID	The username of the user.	
Password	The password of the user. <input type="password"/> Passwords must be at least 8 characters long, and have at least three of these: Upper case, lower case, digit, special character. <input type="password"/> Lost passwords cannot be recovered.	Web: System > Interfaces > Users
Write	Allows the user to change configuration settings.	DCTools: Configuration >
Backup	Allows the user to download configuration or snapshot files.	Communications > Remote Access Protocols
Restore	Allows the user to upload configuration or snapshot files.	
Execute Commands	Allows the user to stop and start control processes.	
Upgrade Firmware	Allows the user to upgrade firmware.	
Administrator	Allows the user to edit the user list and change user access settings.	
SNMP V3	Assign the SNMP V3 rights for this user. If SNMP V3 is enabled for a user, a remote SNMP V3 manager can use this user / password to access the SC300.	
<input type="password"/> The default user and password are: <ul style="list-style-type: none"> ▪ User: SC300 ▪ Password: Factory300 		

Overview



- The dc power system contains hazardous voltages and hazardous energy levels. Before undertaking any maintenance task refer to the Warnings in the dc power system Installation and Operation Guide.
- If a maintenance task must be performed on a "live" system then take all necessary precautions to avoid short-circuits or disconnection of the load equipment, and follow any "live-working" instructions applicable to the site.
- Only perform the maintenance tasks described in the Maintenance chapter. All other tasks are classified as Servicing. Servicing must only be performed according to specific instructions and only by personnel authorized by Eaton. This includes disassembly and/or servicing of any modules.
- For further information on Servicing contact your local Eaton dc product supplier, or refer to the contact details on page 159.

Topic	Page
Troubleshooting	117
Replacing the System Controller or I/O Board	122

Troubleshooting

Use the table to troubleshoot minor installation and operational problems. For additional assistance see contact details on page 159. Return items for replacement or repair with a completed Equipment Incident Report on page 156.

Problem	Possible Cause	Required Action
SC300 displays a dc power system alarm message.		See Alarm Descriptions on page 127.
SC300 LCD is blank and green Power On LED is off.	RXP/power cable is disconnected from the SC300.	Connect cable from connector YS11 to the dc power system voltage feed module (see Connections on page 4). Wait for start-up to complete.
	The ac supply is off and the batteries are not connected because the Low Voltage Disconnect (LVD) has disconnected.	None. The power system including the SC300 will return to normal operation when the ac supply is within its specified voltage range.
	Faulty Voltage Feed Module (VFM) or faulty SC300.	Replace faulty unit.
SC300 LCD is blank and green Power On LED is on.	SC300 is in start-up mode	Wait for start-up to complete. See Starting the SC300 on page 7.
	Faulty SC300	Replace faulty SC300.

Problem	Possible Cause	Required Action
SC300 Red LED or Yellow LED is on.	An alarm is active.	Check the type of alarm on the LCD or with <i>Web</i> or <i>PowerManagerII</i> . See Alarm Descriptions on page 127.
Unable to change settings from SC300 keypad.	Keypad access is set to <i>Read Only</i> or <i>PIN Protected</i> .	See Keypad Access Security on page 12.
Rectifier does not shutdown when LBRS is enabled.	The load is too high for a rectifier to be shut down.	See Load Based Rectifier Shutdown on page 43.
	Load Based Rectifier Shutdown is not available with APR48-3G (prior to PR5), EPR48-3G, APR24-3G and CR48-3G rectifiers.	See Load Based Rectifier Shutdown on page 43.
Monitor OK relay (RY6) is de-energized.	An active alarm, digital input or analog input is mapped to this relay.	Check relay mapping. See Digital Outputs on page 88.
	Problem with power or communications to I/O board.	Check all connections (see Connections on page 4).
	SC300 or I/O board software corrupt or hardware fault.	Replace faulty unit.
Incorrect battery or load current readings.	Bus voltage sense polarity is incorrect.	Check the bus voltage sense polarity and correct if necessary.
	Incorrectly configured shunt inputs.	Check shunt mapping and gain is correct.
	Current is within the <i>Battery State Threshold</i> . See details on page 66.	None, normal operation.
Battery test will not run. The cause indicated in Web is "Alarms Active" but there are no active alarms.	Battery test will not run if a relevant alarm is active or pending even if the alarm is disabled. Examples of relevant alarms are: <i>Battery Fuse Fail</i> , <i>Rectifier No Load</i> and <i>System Overload</i> .	Clear the cause of the alarm.
	Battery test will not run if the <i>System Overload</i> alarm is set to "Redundancy" and only one rectifier is installed.	Set the <i>System Overload</i> alarm to "Total Capacity" or install another rectifier.
SC300 or Web displays ??? or N/A	Failed, disconnected or unconfigured sensor.	Replace, connect or configure sensor.
	Faulty or disconnected voltage feed module.	Replace or connect voltage feed module.
	Incorrect I/O board mapping.	Check I/O board mapping. See details on page 139.
Modem /RS-232 communications problem.	Incorrect, disconnected or faulty cable.	Check an RS-232 straight-thru cable is plugged into XS1 and the modem. Replace faulty cable.
	Access to RS-232 connector XS1 is restricted.	Use a DB9 ribbon cable extension (Farnell part number 869-6411).
	Incorrect communications	See PSTN Modem Communications on

Problem	Possible Cause	Required Action
	settings.	page 111 or GSM Modem Communications on page 111.
	Incorrect modem setup string.	Refer to the AT command section in the modem's manual.
	Modem not powered or other modem problem.	Refer to the modem's manual.
	Incompatible modem.	Contact your Eaton dc product supplier or Eaton for advice. See Worldwide Support on page 159.
	Password required to change settings.	See Write Access Password on page 114.
Serial communications are disabled	<i>S3P Access</i> is disabled.	Set <i>S3P Access</i> to Enabled. See details on page 114.
Ethernet communications problem	Incorrect, disconnected or faulty cable.	Check a network patch cable is connected from XS31 to a live network outlet. Replace faulty cable.
	Cannot connect to the SC300 after changing the IP address or http/https setting.	For V1.11 software, these changes only apply after a reboot. Restart the SC300.
	Ethernet link is not active.	On the Ethernet connector (XS31) check: <ul style="list-style-type: none"> - Yellow LED is continuously lit to show link is active. - Green LED flashes to show traffic is reaching the SC300. See the diagrams on page 1 for position of the Ethernet connector.
	Incorrect communications settings.	See Ethernet Communications on page 101.
	SC300 serial communications are disabled.	Check <i>S3P Access</i> is enabled. See details on page 114.
	Password required to change settings (using PowerManagerII).	See Write Access Password on page 114.
Web communications problem	Ethernet communications problem.	See previous entry.
	Cannot connect to web server.	Check IP address and other settings in SC300 are correct. Check correct IP address is used in web browser address bar. See Ethernet Communications on page 101. Check <i>HTTP Access</i> or <i>HTTPS Access</i> is enabled. See Web Access Security on page 115.
	Cannot log on to web server.	Incorrect Logon ID or Password, or no active users setup. Use DCTools or SNMP to set up an active user. See Web Access Security on page 115.
	Web communications lost	Check that the SC300 is operating.

Problem	Possible Cause	Required Action
	(<i>Comms Lost</i> error message).	Check the Ethernet communications connections. See previous entry. Check web browser type and version. See Compatible Software on page 4.
	A user cannot change settings, Backup or Restore, Execute Commands, Upgrade Firmware, or Edit User List.	Check the user's access levels. See Web Access Security on page 115.
	Incorrect, disconnected or faulty cable.	Check a micro USB cable is plugged into the USB port and a PC USB port. Replace faulty cable.
	Message "User access has changed, reload page"	Refresh the browser (control-F5). If that does not work, restart the browser.
USB communications problem	SC300 serial communications are disabled.	Check <i>S3P Access</i> is enabled. See details on page 114.
	USB driver not loaded	Use Device Manager to check that the driver is correctly installed.
	Time needs to be set.	See SC300 Internal Clock on page 17.
SC300 time/date is incorrect SC300 time can be set, but is incorrect when SC300 restarts.	The internal battery is dead.	Return the SC300 for service. (If removed, the battery must be disposed of according to the manufacturer's instructions.)
String Fail Alarm	The Battery Symmetry system has detected a voltage imbalance in one of the battery strings.	See Battery Symmetry Monitoring in the dc power system Installation and Operation Guide.
	A Battery Symmetry sense wire is disconnected.	Check the sense wires. See Battery Mid-point Monitoring in the dc power system Installation and Operation Guide.
	I/O board is not powered or faulty. A Battery Symmetry sense wire is disconnected.	Check connection to YH3 on I/O board. See Connections on page 4. Replace I/O board if faulty. Check the sense wires.
I/O board Power/Comms OK LED is off	I/O board is responding to an <i>Identify</i> command from the SC300. I/O board is not powered or faulty.	None, this is normal operation. See details on page 79. Check connection to YH3 on I/O board. See Connections on page 4. Replace I/O board if faulty.
I/O board Power/Comms OK LED is flashing.	LVD contactor is energized. I/O board is responding to an <i>Identify</i> command from the SC300.	None, this is normal operation. See details on page 79.
LVD Status LED(s) (on I/O board) are on.	LVD contactor is de-energized. LVD contactor is energized.	None, this is normal operation.

Problem	Possible Cause	Required Action
LVD Status LED(s) are off (I/O board Power On LED is on).	The contactor is in the wrong state (SC300 internal state does not match signal from contactor auxiliary switch).LVD contactor is de-energized.	Check the electrical and mechanical operation of the contactor and auxiliary switch. Check all wiring and connectors. See Connections on page 4.
LVD Status LED(s) flashing.	LVD Type setting is incorrect. The contactor is in the wrong state (SC300 internal state does not match signal from contactor auxiliary switch).	Check LVD Type setting. Check the electrical and mechanical operation of the contactor and auxiliary switch. Check all wiring and connectors. See Connections on page 4.
	LVD settings incorrect. LVD Type setting is incorrect.	Check LVD is enabled and set to correct values. See details on page 50. Check that the LVD manual control is set to AUTO. See details on page 48. Check that the contactor is correctly configured and mapped to the I/O board. See details on page 51. Check LVD Type setting.
LVD contactor(s) not operating.	Contactor is disconnected. LVD settings incorrect.	Check the control and dc power cables are connected. See details on page 4. Check LVD is enabled and set to correct values. See details on page 50. Check that the LVD manual control is set to AUTO. See details on page 48. Check that the contactor is correctly configured and mapped to the I/O board. See details on page 51.
	Load fuse or disconnect device open. Contactor is disconnected.	Check for open fuse or disconnect device. Check the control and dc power cables are connected. See details on page 4.
System has no dc output (rectifiers are on).	LVD contactor has disconnected the load. Load fuse or disconnect device open.	Use the web to check LVD is enabled and set to correct values. (LVD status LED on the I/O board is on when contactor is energized.) Check that the I/O board is connected (Power LED is on). Check that the LVD control and power cables connections on page 4. Check the connections from the load bus to the LVD. Check for open fuse or disconnect device.
	Battery disconnect device or fuse open. LVD contactor has disconnected the load.	Check for open battery disconnect device or fuse. Use the web to check LVD is enabled and set to correct values. (LVD status LED on the I/O board is on when contactor is energized.) Check that the I/O board is connected (Power LED is on). Check that the LVD control and power cables connections on page 4. Check the connections from the load bus to the LVD.

Problem	Possible Cause	Required Action
System has no battery input	LVD has disconnected the battery because ac supply is off and the battery is fully discharged. Battery disconnect device or fuse open.	None. The battery will be automatically reconnected when the ac supply is restored. Check for open battery disconnect device or fuse.
	LVD contactor is open. LVD has disconnected the battery because ac supply is off and the battery is fully discharged.	Use DCTools/Web to check LVD is enabled and set to correct values. (LVD status LED on the I/O board is on when contactor is energized.) Check that the I/O board is connected (Power LED is on). Check that the LVD control and power cables are connected. See Connections on page 4. Check the connections from the battery bus to the LVD. None. The battery will be automatically reconnected when the ac supply is restored.
	LVD contactor is open.	Use DCTools/Web to check LVD is enabled and set to correct values. (LVD status LED on the I/O board is on when contactor is energized.) Check that the I/O board is connected (Power LED is on). Check that the LVD control and power cables are connected. See Connections on page 4. Check the connections from the battery bus to the LVD.

Replacing the System Controller or I/O Board

The SC300 system controller or the I/O board can be replaced without switching off the dc power system and disconnecting the equipment it powers.

If the system is configured for only one IO Board, the SC300 will automatically detect the IO Board and assign it as IOB 1 (address 1).

If more than one IO Board is to be installed, refer to I/O Board or Fan Controller serial number mapping on page 139.

The specific procedures depend on the system configuration. Refer to the dc power system Installation and Operation Guide.

Refer also to:

- Application Note AN0145 Replace SC200 in a Live System
Note: this also applies to SC300.
- Application Note AN0146 Replace IO Board in a Live System

SC300 system controller

Communications

USB	Type:	USB 2.0
	Connector:	USB Micro type AB
RS-232	Interface:	RS-232 (DTE)
	Connector:	DB9M
RS-485 (some versions only)	Connector:	DB9M
Ethernet	Interface:	100baseT
	Connector:	RJ45
	Protocols:	TCP/IP, SNMP, S3P over IP, http (Web), https (secure Web), SMTP, Modbus-TCP, Serial Server
	MAC Address:	See details on page 101.
	Web browser:	Microsoft Edge, Mozilla Firefox 3.0 or later, Chrome.

IOBGP I/O Board

The following specifications apply to a single IOBGP I/O board connected to the SC300 system controller.

Digital Outputs/Alarm Relays (IOBGP)

Number of Digital Outputs/Relays (one also used for Monitor OK alarm)*	
	IOBGP-00/ 01 6
	IOBGP-10/11 10
	IOBGP-20/21 8
Contact Arrangement	One changeover contact per relay
Contact Rating	0.1A @ 60V dc maximum
Connectors	Screwless terminal blocks
Wire Size	0.5 - 2.0mm ² [20 - 14 AWG]
Maximum Cable Length	20m (65 feet)
Isolation	Relay connections are isolated to 500V dc from all other circuitry, earth and system common.

 * Digital Output 6 is also used as the Monitor Fail alarm relay. It will de-energize if the I/O board loses power or loses communication with the SC300.

Battery Symmetry Monitoring

Number of Strings	Standard: 4 (mid points only), 1 (with quarter points). Quarter points require IOBGP-10/11/20/21) Maximum: 24 (with additional IOBGP-00/01/10/11/20/21 I/O boards)
Range	-35V to +35V with IOBGP-00/01 -60V to +60V with IOBGP-10/11/20/21
Resolution	<30mV
Accuracy	±0.5% at 25°C [77°F], ±1% over rated temperature range
Maximum Cable Length	20m (65 feet)

Digital Inputs (IOBGP)

Number of Digital Inputs	IOBGP-00/01 6 IOBGP-10/11/20/21 9
Connectors	Screwless terminal blocks
Wire Size	0.5 - 2.0mm ² [20 - 14 AWG]
Maximum Cable Length	20m (65 feet)
Input Types	Voltage-free switch or relay contacts only
Input Range	Live Bus to Live Bus + 5V
Input Common	Same bus as used for current shunts (Live bus is standard)
Input Protection	Protected against damage from short circuit to live or common bus

Temperature Sense Inputs (IOBGP)

Number of Temperature Sense Inputs	2 <i>One only connected as standard. Second input available (requires additional temperature sensor).</i>
Range	2.53V to 3.43V (-20 to +70°C [-4 to +158°F])
Resolution	< 0.01V (< 1°C [1.8°F])
Accuracy	±1°C [1.8°F] at 25°C [77°F], ±2°C [3.6°F] over rated temperature range
Maximum Cable Length	20m (65 feet)
Connector	RJ45

Current Sense Inputs (IOBGP)

Number of Current Sense Inputs	3
Range	-50 to +50mV
Resolution	<50µV
Accuracy	±0.5% at 25°C [77°F], ±1% over rated temperature range

Maximum Cable Length	10m (32 feet)
Connector	RJ45

Bus Voltage Sense Input (IOBGP)

Number of Bus Voltage Sense Inputs	1
Range	-60V to +60V
Resolution	30mV
Accuracy	±0.5% at 25°C [77°F], ±1% over rated temperature range
Maximum Cable Length	3m (10 feet)
Connector	MTA156 (2-way)

Low Voltage Disconnect (IOBGP)

Number of contactor connections	
	IOBGP-00/ 01 2
	IOBGP-10/11 3
	IOBGP-20/21 2
Number of LVD channels	16
Contactor Type	Normally Open (NO) with auxiliary contacts only.
Contactor Coil Voltage (nominal)	12V, 24V or 48V
Maximum Hold-in Current	1.2A (per contactor)
Maximum Cable Length	3m (10 feet)
Connector	MTA156 (4-way)

Power and RXP Comms

Maximum Cable Length (from Voltage Feed Module)	24V Systems - 100m (325 feet) 48V Systems - 200m (650 feet)
Connector	RJ45

Alarm Descriptions

AC Fail	All rectifiers report ac supply failure or a digital input with <i>Function</i> set to "AC Fail" is active.
AC Phase 1/2/3 Fail	Phase 1/2/3 of the ac input has failed, i.e. it deviates from the <i>Nominal AC Voltage</i> by more than the <i>AC Phase Fail Threshold</i> . Only available in systems where ac phase voltage is measured.
AC Phase 1/2/3 Voltage	Phase 1/2/3 of the ac input deviates from the <i>Nominal AC Voltage</i> by more than the <i>AC Phase Voltage Threshold</i> . Only available in systems where ac phase voltage is measured.
ACD Fan Fail	The ac distribution cooling system or fan controller has failed (indicated by an active digital input with <i>Function</i> set to "ACD Fan Fail").
Battery Current Limit	Battery Current Limit (BCL) is active. See Battery Current Limit on page 29.
Battery End of Life	If <i>Battery End of Life date</i> has been set, then this alarm will activate when that date is reached.
Battery Fuse Fail	A battery fuse has blown or a battery disconnect device has operated (indicated by an active digital input with <i>Function</i> "Battery Fuse Fail").
Battery Temperature High	The analog input with <i>Function</i> set to "Battery Temperature" has a value above the <i>Battery Temperature High Threshold</i> . This alarm indicates either thermal runaway of the batteries or that the batteries are operating at a temperature that may cause reduced battery life.
Battery Temperature Low	The analog input with <i>Function</i> set to "Battery Temperature" has a value below the <i>Battery Temperature Low Threshold</i> . This alarm indicates a risk to the standby power system battery as lower temperatures reduce the battery capacity.
Battery Test	The Battery Test control process is active. See Battery Test on page 31.
Battery Test Fail	The batteries do not have the required capacity or are not fully charged. See Battery Test on page 31.
Battery Test Cancelled	A scheduled battery test has failed to start or been cancelled when running.
Battery End of Life	The current date is after the date set in <i>Battery Design End of Life Date</i> . This alarm only operates if both <i>Battery Installed Date</i> and <i>Battery Design End of Life Date</i> settings have been changed.
Cabinet Fan Fail	A cabinet fan has failed (indicated by an active digital input with <i>Function</i> set to "Cabinet Fan Fail").
Characterizing Battery	The SC300 is running a battery characterization, which is a full depth test battery discharge. See details on page 70.
Configuration Error	One of the following is true: <ul style="list-style-type: none"> • The Rectifier Current Limit is set higher than the Maximum Current Limit of all the registered rectifiers. See details on page 40. • The OVSD Set Point is out of the range of any registered rectifiers. See details on page 40. • More than one digital output are mapped to the same relay on an I/O board or SiteSure-3G Module. See details on page 88. • An LVD contactor is in <i>Conflict</i> state. See details on page 51. • <i>Smart Alarm Based Disconnect</i> is <i>Enabled</i>, but the corresponding <i>Smart Alarm</i> is <i>Disabled</i>. See details on page 51. • A <i>Smart Alarm</i> source has an invalid <i>Source Triggered</i> setting. <p>To see the cause of this alarm:</p>

- Web – go to *Alarm Info* at the end of the Alarms Table
- Front panel – press up arrow to show alarm list. Scroll down to the bottom.

DCDC Fail	An attached DC/DC converter has failed.
DC Input Fail	One or more solar chargers has no DC input voltage.
DO Manual	A digital output is set to manual control (control state is set to <i>Active</i> or <i>Inactive</i>). See Digital Outputs on page 88.
Equalize	The Equalize control process is active. See Equalize on page 32.
Fast Charge	The Fast Charge control process is active. See Fast Charge on page 33.
Generator Fail	<i>Generator Control</i> is active but the SC300 has not detected that the ac supply is present (rectifiers have not turned on) after the <i>Generator Fail Alarm Recognition Period</i> .
High Float	The bus voltage is above its normal range (set by the <i>High Float Threshold</i>). <i>If High Float Tracking is enabled, the High Float threshold will increase when the bus voltage increases due to temperature compensation. The threshold change will be the same as the bus voltage change.</i>
High Load	The bus voltage is higher than the safe range for the load and/or battery (set by the <i>High Load Threshold</i>).
I/O Comms Lost	The SC300 has lost communication with a mapped I/O board or SiteSure-3G module. Or, an input or output is mapped to an invalid I/O board or SiteSure-3G module. See I/O Board Mapping on page 139.
In Discharge	<i>Battery Charge State</i> is <i>Discharge</i> (see details on page 65).
Load Fuse Fail	A load fuse has blown or a load disconnect device has operated (indicated by an active digital input with <i>Function</i> "Load Fuse Fail").
Low Float	The bus voltage is below its normal range (set by the <i>Low Float Threshold</i>). <i>If Low Float Tracking is enabled, the Low Float threshold will decrease when the bus voltage decreases due to temperature compensation. The threshold change will be the same as the bus voltage change.</i>
Low Load	The bus voltage is lower than the safe range for the load and/or battery (set by the <i>Low Load Threshold</i>).
Low Rectifier Capacity	The load current is greater than the available current from the rectifiers after taking away one redundant rectifier.
LVD Characterization Error	An LVD contactor must be characterized. See Low Voltage Disconnect on page 48.
LVD Disconnected	An LVD contactor has disconnected the battery or load. See Low Voltage Disconnect on page 48.
LVD Fail	An LVD contactor is faulty or the control cable from the I/O board is disconnected. See Low Voltage Disconnect on page 48.
LVD Manual	An LVD is set to MANUAL CONNECT or MANUAL DISCONNECT. See Low Voltage Disconnect on page 48.
MOV Fail	One or more MOV cartridges have failed and must be replaced (indicated by an active digital input with <i>Function</i> set to "MOV Fail").
Multiple Rectifier Comms Lost	More than one rectifier is missing. See also Rectifier Comms Lost on page 129.

Multiple Rectifier Fail	<p>Multiple rectifiers are faulty or their ac supply has failed without causing partial or total ac supply failure.</p> <p>Inhibited by: <i>AC Fail</i> and <i>Partial AC Fail</i> (if no more than one rectifier has failed while still detecting the AC supply). See details of Alarm Inhibiting on page 55.</p>
Multiple Solar Comms Lost	<p>More than one solar charger is missing.</p>
Normal Charge	<p>The DC power system is in normal float charging mode.</p>
Partial AC Fail	<p>A digital input with <i>Function</i> set to "Phase Fail" is active, or more than 20% of single-phase rectifiers are reporting ac supply failure, or all 3-phase rectifiers are reporting loss of the same phase.</p> <p>Inhibited by: <i>AC Fail</i>. See details of Alarm Inhibiting on page 55.</p>
Peak Load Reduction	<p>The system is running in PLR mode, with the rectifiers turned down and the load being supplied from the batteries. For more details, see Peak Load Reduction on page 36.</p>
Rectifier Comms Lost	<p>Normally this alarm indicates that a rectifier has been removed during routine maintenance. However, faulty rectifier communications or losing the rectifier communications bus can also trigger this alarm. If removing multiple rectifiers triggers this alarm, reset it from the keypad before it triggers an external alarm.</p> <p>Inhibited by: <i>Multiple Rectifier Comms Lost</i>. See details of Alarm Inhibiting on page 55.</p>
Rectifier Current Limit	<p>Rectifier(s) in current limit.</p>
Rectifier Fail	<p>A rectifier is faulty or its ac supply has failed without causing partial or total ac supply failure.</p> <p>Inhibited by: <i>Multiple Rectifier Fail</i>, <i>AC Fail</i> and <i>Partial AC Fail</i> (if no rectifiers have failed while still detecting the AC supply). See details of Alarm Inhibiting on page 55.</p>
Rectifier No Load	<p>The total rectifier current is less than 2% of the maximum system output current or is less than 2A.</p> <p>Inhibited by: <i>AC Fail</i>. See details of Alarm Inhibiting on page 55.</p>
Rectifier OverTemperature	<p>Rectifier(s) operating in temperature turndown mode, because of high ambient temperature or low ac supply voltage.</p>
RIP Comms Lost	<p>When the SC300 is set up for A/B communications, communications with the other SC300 has been lost</p> <p style="text-align: center;">☐ <i>Refer to separate application notes on A/B communications. Requires special hardware.</i></p>
RTC Low Battery	<p>The internal battery has failed, causing the SC300 to lose the correct time setting after a restart.</p>
Sensor Fail	<p>The current, temperature or voltage sensing system is faulty, or the I/O board mapping is incorrect.</p>
Site Backup Time Remaining	<p>The power system has been running in AC fail from batteries for more than the time specified by <i>Site Backup Time</i>.</p>
Solar Comms Lost	<p>One or more solar chargers has been removed or communications failed.</p> <p>Inhibited by: <i>Multiple Solar Comms Lost</i>). See details of Alarm Inhibiting on page 55.</p>
Solar Fail	<p>At least one solar charger has failed.</p> <p>Inhibited by: <i>Multiple Solar Fail</i>. See details of Alarm Inhibiting on page 55.</p>

Standby Mode	The SC300 is on but inactive. Another system controller controls the dc power system. If the other system controller fails or is disconnected then the SC300 in Standby Mode will become active (after a short delay).
String Fail	There is a voltage imbalance in one of the battery strings. See Battery Symmetry Monitoring on page 67.
System Overload	<p>The power system is operating close to its maximum capacity and more rectifiers are needed. The System Overload threshold is configurable. See System Overload Alarm on page 56.</p> <p>Inhibited by: <i>AC Fail</i>. See details of Alarm Inhibiting on page 55.</p>
System Overload B	This is identical to <i>System Overload</i> . This alarm is enabled when another system overload alarm is needed with different settings.
Unknown Hardware	The SC300 has detected an unknown type of device on the RXP bus. Contact your Eaton DC product supplier for advice.
Unmapped IOB Found	An I/O board or SiteSure-3G module is connected to the SC300, but its serial number is not in the <i>I/O Board to Serial Number Mapping</i> table. See I/O Board Mapping on page 139.
Unstable Rectifier AC	The AC voltages measured by rectifiers are unstable. This usually indicates the neutral connection has been lost.
Wrong Battery Polarity	<p>An analog input with <i>Function</i> set to "Reverse Battery Detect" has a value above the <i>Bus Voltage</i>.</p> <p>This alarm indicates the battery is connected with wrong polarity. See Reverse Battery Detection on page 74.</p>

Connector Pin-outs

System Controller Connector Pin-outs

Connector	Type	Purpose	Pin	Description
XS1	DB9M	RS-232 / RS485 Serial Interface	1	-
			2	
			3	
			4	
			5	
			6	
			7	
			8	
			9	
XS31	RJ45	Ethernet Interface	1	Rx
			2	Rx
			3	Tx
			4	-
			5	-
			6	Tx
			7	-
			8	-
YS11	RJ45	RXP System Communications	1	System Positive 24/48V
			2	System Positive 24/48V
			3	CANL (some versions only)
			4	RS485-A (some versions only)
			5	RS485-B (some versions only)
			6	CANH (some versions only)
			7	System Negative 24/48V CAN ground
			8	System Negative 24/48V
USB	USB micro AB	USB Serial Interface	1	VCC (+5 V dc)
			2	Data -
			3	Data +
			4	ID
			5	Ground

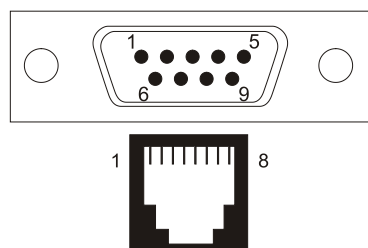

RS-232 D9M and RJ45 connector pin-outs

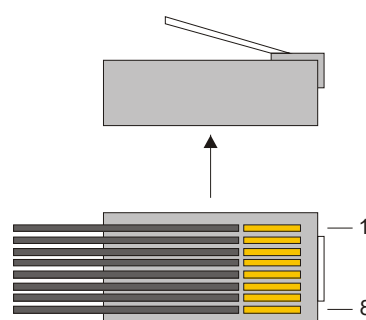

RJ45 plug pin-outs

I/O Board (IOBGP-xx) Connector Pin-outs

See input and output specifications on page 123.

Connector	Type	Purpose	Pin	Description
XH4	MTA 156	LVD 1 Interface	1	Coil -
			2	Coil +
			3	LVD 1 auxiliary switch
			4	Auxiliary switch common
XH5	MTA 156	LVD 2 Interface	1	Coil -
			2	Coil +
			3	LVD 2 auxiliary switch
			4	Auxiliary switch common
XH3	MTA 156	LVD 3 Interface <i>IOBGP-10/11 only</i>	1	Coil -
			2	Coil +
			3	LVD 2 auxiliary switch
			4	Auxiliary switch common
XH6	RJ45	Current Sense Inputs <i>Current sensor must be on system live. Sensor signal is referenced to live bus.</i>	1	Current Input 1 Common
			2	Current Input 1
			3	+12V out
			4	Current Input 2 Common
			5	Current Input 2
			6	0V out
			7	Current Input 3 Common
			8	Current Input 3
XH7	RJ45	Temperature Sense Inputs <i>Sensor signal is referenced to live bus.</i>	1	-
			2	-
			3	-
			4	Temp Sense 1+
			5	Temp Sense 1-

Connector	Type	Purpose	Pin	Description
			6	-
			7	Temp Sense 2+
			8	Temp Sense 2-
XH8	MTA 156	LVD Power	1	Bus live
			2	Bus common
XH9	MTA 156	Bus Voltage Sense Input	1	Controller reference (Bus live)
			2	Controller sense (Bus common)
XH12A	MTA 156	Battery Symmetry sense inputs <i>Sensor signal is referenced to live bus.</i>	1	String 1 Mid-point / Quarter-point 1
			2	String 2 Mid-point / Quarter-point 2
			3	String 3 Mid-point / Quarter-point 3
			4	String 4 Mid-point / Quarter-point 4
XH15A		Digital inputs D1-D3 <i>Digital input signals are referenced to live bus.</i>	1	D1 input
			2	0V
			3	D2 input
			4	0V
			5	D3 input
			6	0V
XH15B		Digital inputs D4-D6 <i>Digital input signals are referenced to live bus.</i>	1	D4 input
			2	0V
			3	D5 input
			4	0V
			5	D6 input
			6	0V
XH15D		Digital inputs D10-D13 <i>IOBGP-10/11 only</i> <i>Digital input signals are referenced to live bus.</i>	1	D11 input
			2	0V
			3	D12 input
			4	0V
			5	D13 input
			6	0V
XH16/XH17		Digital relay outputs 1-2 <i>Digital outputs are voltage-free.</i>	1	Relay 1 normally closed (NC)
			2	Relay 1 normally open (NO)
			3	Relay 1 Common (COM)
			4	Relay 2 normally closed (NC)
			5	Relay 2 normally open (NO)
			6	Relay 2 Common (COM)
XH18/XH19		Digital relay outputs 3-4 <i>Digital outputs are voltage-free.</i>	1	Relay 3 normally closed (NC)
			2	Relay 3 normally open (NO)

Connector	Type	Purpose	Pin	Description
		<i>free.</i>	3	Relay 3 Common (COM)
			4	Relay 4 normally closed (NC)
			5	Relay 4 normally open (NO)
			6	Relay 4 Common (COM)
XH20/XH21		Digital relay outputs 5-6* <i>Digital outputs are voltage-free.</i>	1	Relay 5 normally closed (NC)
			2	Relay 5 normally open (NO)
			3	Relay 5 Common (COM)
			4	Relay 6 normally closed (NC)
			5	Relay 6 normally open (NO)
			6	Relay 6 Common (COM)
XH22/XH23		Digital relay outputs 7-8 <i>IOBGP-10/11/20/21 only</i> <i>Digital outputs are voltage-free.</i>	1	Relay 7 normally closed (NC)
			2	Relay 7 normally open (NO)
			3	Relay 7 Common (COM)
			4	Relay 8 normally closed (NC)
			5	Relay 8 normally open (NO)
			6	Relay 8 Common (COM)
XH20/XH21		Digital relay outputs 9-10 <i>IOBGP-10/11 only</i> <i>Digital outputs are voltage-free.</i>	1	Relay 9 normally closed (NC)
			2	Relay 9 normally open (NO)
			3	Relay 9 Common (COM)
			4	Relay 10 normally closed (NC)
			5	Relay 10 normally open (NO)
			6	Relay 10 Common (COM)
YH3	RJ45	DC power system digital inputs <i>Digital input signals are referenced to live bus.</i>	1	Load Fuse Fail
			2	Battery Fuse Fail
			3	+12V out
			4	AC Distribution Fan Fail
			5	AC Distribution MOV Fail
			6	0V out (system live - protected)
			7	-
			8	System common - protected
YH11/ YH11A (IOBGP- 10/11/20/21 only)	RJ45	RXP System Communications	1	System Positive 24/48V
			2	System Positive 24/48V
			3	-
			4	RS485-A
			5	RS485-B
			6	-
			7	System Negative 24/48V

Connector	Type	Purpose	Pin	Description
			8	0V

 * Digital Output 6 is also used as the Monitor Fail alarm relay. It will de-energize if the I/O board loses power or loses communication with the SC300.

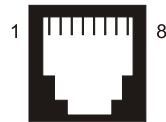

RJ45 connector pin-outs

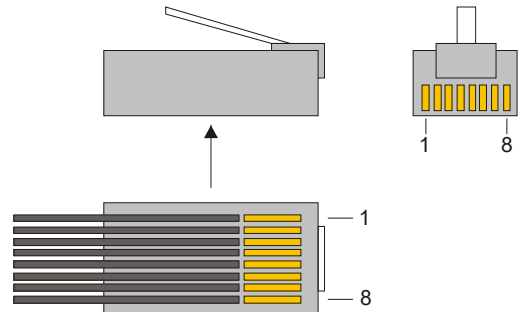

RJ45 plug pin-outs

System Event Types

Event Type	Description	Additional Event Information
AI High Activation	An analog input high threshold alarm has become active.	Analog input name
AI High Deactivation	An analog input high threshold alarm has become inactive.	Analog input name
AI Low Activation	An analog input low threshold alarm has become active.	Analog input name
AI Low Deactivation	An analog input low threshold alarm has become inactive.	Analog input name
Alarm Activation	An alarm has become active.	Alarm name
Alarm Deactivation	An alarm has become inactive.	Alarm name
Battery State Reset	The battery state has been reset, setting the value of Ah Discharged back to zero.	
Clock Change From	The clock was changed to this new Event Log Time from the old Event Information time. When the clock is changed, two event log entries are recorded. The first is the Clock Change To event and the second is the Clock Change From event.	
Clock Change To	The clock was changed to the new Event Information time from the old Event Log Time. When the clock is changed, two event log entries are recorded. The first is the Clock Change To event and the second is the Clock Change From event.	
Configuration Change	The configuration database was changed.	
Control Process Start	An SC300 control process has started.	
Control Process Stop	An SC300 control process has stopped.	
DI Activation	A digital input alarm has become active.	Digital input number name
DI Deactivation	A digital input alarm has become inactive.	Digital output number, name
DO Control Manual Active	A digital output has been manually activated.	Digital output number, name

Event Type	Description	Additional Event Information
DO Control Automatic	A digital output has been set to Automatic.	Digital output number, name
DO Control Manual Inactive	A digital output has been manually deactivated.	Digital output number, name
Generator Start	The generator has been started.	
Generator Stop	The generator has been stopped.	
Login	A user has logged in using web.	
Logs Cleared	The event and data logs have been cleared.	
Manual Equalize Start	An Equalize cycle has been manually started.	
Manual Equalize Stop	An Equalize cycle has been manually stopped.	
Manual Fast Charge Stop	A Fast Charge cycle has been manually stopped.	
Peak Load Reduction Start	The PLR process has been started.	
Peak Load Reduction Stop	The PLR process has been stopped.	
Rectifier Restart	A rectifier was started manually. This excludes events where a rectifier starts due to Load-Based Rectifier Shutdown or after the removal of a fault condition.	
Rectifier Shutdown	A rectifier was shut down manually. This excludes events where a rectifier shuts down due to Load-Based Rectifier Shutdown or a fault condition.	
Reset System	The SC300 has been reset.	
Smart Alarm Activation	A smart alarm has become active.	Smart Alarm name
Smart Alarm Deactivation	A smart alarm has become inactive.	Smart Alarm name
Start Up	Records when the controller started running.	

The SC300 uses mappings to allow it to associate internal functions, alarms and physical I/O devices.

- ☐ *A default mapping is set at the factory before delivery. Usually this default mapping will not need to be changed.*

I/O Board Mapping

The serial numbers of an I/O board, SiteSure-3G modules, and Fan Controllers, and the physical connectors on the board/modules are mapped to logical numbers in the SC300. This allows the physical inputs and outputs (including LVD contactors) to be recognized by the SC300.

I/O Board or Fan Controller serial number mapping

Each I/O board serial number must be mapped to a logical *IOB Number*.

Usually, I/O board serial number mappings only need to be changed if:

- The I/O board is changed or added. See details on page 122.
- The SC300 is changed and/or a new configuration file is loaded into the SC300. See details on page 122.

- ☐ *This mapping is not included in configuration files.*

- ☐ *If the system is configured for only one IO Board, the SC300 will automatically detect it and assign it as IOB 1. If more IO Boards are installed, or in a new system with more than one IO board, or if an SC300 is changed or loaded with a new configuration file, the IO Board mapping must be set. Input/output, sensors and most voltage control processes are only available if this mapping is set.*

► To manually map I/O boards or Fan Controllers

Either:

- Use the SC300 keypad to go to: *Settings > IOBs*. The serial numbers of registered Input / Output boards are displayed.
- Select an unmapped Input / Output board or Fan Controller (identified as *New*). Press *Enter*. Identity information is displayed and the I/O board LED will flash.
- Press *Map* and select an unused IOB Number (or one marked as *Missing*, if replacing an I/O board). Press *Enter*.

Or:

- Use the SC300 keypad to go to Alarms (as a shortcut, simply press the up arrow  and select *Unmapped IOB*).
- Press *Clear*.
- Select the IOB number to map to.
- Press *Save*

Or:

- On web, go to: *System > Interfaces > RXP*.
- In DCTools, go to *Configuration > RXP*.
- Copy the I/O board serial number(s) from the *RXP Devices* table to the *I/O Board to Serial Number Mapping* table to map an *IOB Number* to each I/O board (overwrite an existing

serial number if required).

 If multiple SiteSure-3G modules are installed use the I/O board Identify function to physically identify each board. See details on page 79.

I/O connector mapping

Each I/O connector (analog input, digital input and digital output) on an I/O board must be mapped to a logical IOB Number and IOB AI, IOB DI or IOB DO Number.

► To map I/O connectors

See Analog Inputs on page 82, Digital Inputs on page 86 and Digital Outputs on page 88.

The following tables show the default connector mappings for the first IO Board:

Analog Input	Name	Function*	IOB Number	IOB AI Number	Connector
1	XH9 Bus Voltage	Bus Voltage	1	1	XH9
2	XH12 Mid-point 1	Battery Mid-point / Quarter-point ³	1	2	XH12A
3	XH12 Mid-point 2	Battery Mid-point / Quarter-point	1	3	XH12A
4	XH12 Mid-point 3	Battery Mid-point / Quarter-point	1	4	XH12A
5	XH12 Mid-point 4	Battery Mid-point / Quarter-point	1	5	XH12A
6	XH6 Battery Current	Battery Current	1	6	XH6
7	XH6 Current 2	User Defined	1	7	XH6
8	XH6 Current 3	User Defined	1	8	XH6
9	XH7 Battery Temp	Battery Temperature	1	9	XH7
10	XH7 Temperature 2	User Defined	1	10	XH7

Digital Input	Name	Function*	IOB Number	IOB DI Number	Connector
1	Digital Input 1	User Defined	1	1	XH15A
2	Digital Input 2	User Defined	1	2	XH15A
3	Digital Input 3	User Defined	1	3	XH15A
4	Digital Input 4	User Defined	1	4	XH15B
5	Digital Input 5	User Defined	1	5	XH15B
6	Digital Input 6	User Defined	1	6	XH15B
7	Load Fuse Fail	Load Fuse Fail	1	7	YH3
8	Battery Fuse Fail	Battery Fuse Fail	1	8	YH3

³ Quarter-point inputs are only available with IOBGP-10/11/20/21.

9	ACD Fan Fail	ACD Fan Fail	1	9	YH3
10	MOV Fail	MOV Fail	1	10	YH3
11#	Digital Input 10	User Defined	1	11	XH15D
12#	Digital Input 11	User Defined	1	12	XH15D
13#	Digital Input 12	User Defined	1	13	XH15D

* *Function* is an internal analog or digital input value used by the SC300 for voltage control processes, and/or to generate System States, and/or to generate system alarms.

Digital inputs 10, 11, 12 are only available with IOBGP-10/11/20/21

Digital Output	Name	IOB Number	IOB DO Number	Connector
1	Summary Non Urgent	1	1	XH16
2	Low/High Load	1	2	XH17
3	Rectifier Fail	1	3	XH18
4	AC Fail	1	4	XH19
5	Load/Batt Disconnect	1	5	XH20
6	IOBGP 1 RY6/Mon OK	1	6	XH21
7 #	Digital output 7	1	7	XH22
8 #	Digital output 8	1	8	XH23
9 #	Digital output 9	1	9	XH24
10 #	Digital output 10	1	10	XH25

Digital outputs 7 to 10 are only available with IOBGP-10/11/20/21 or IOBSS-10.

 Digital outputs are activated by mappings from alarms (see Digital Output (Relay) Mapping on page 141) or by a test (see Digital Outputs on page 88).

LVD connector mappings

For details refer to LVD Configuration on page 50.

Digital Output (Relay) Activation

Any alarm can activate one or two digital outputs (A and B).

► **To map digital outputs**

- See System Alarms on page 54, Smart Alarms on page 57, Analog Inputs on page 82, Digital Inputs on page 86 and Digital Outputs on page 88.

END-USER LICENSE AGREEMENT SC300 Controller

Last Revised Date: 13 August 2019

Eaton Intelligent Power Ltd. (“**EATON**”) owns and operates the SC300 Controller software (“**Product Software**”).

This End-User License Agreement (“**Agreement**”) governs the use of the Product Software. Other sites, content or online services owned or controlled by Eaton have their own terms of use/end-user license agreement and should be reviewed. Eaton licenses the use of the Product Software to you subject to the terms of this Agreement.

IMPORTANT, PLEASE READ THIS AGREEMENT BEFORE REGISTERING, ACCESSING OR USING THE PRODUCT SOFTWARE. THIS AGREEMENT IS A BINDING LEGAL CONTRACT BETWEEN YOU (IF REGISTERING AS AN INDIVIDUAL) AND/OR THE ENTITY YOU REPRESENT (IF REGISTERING AS A BUSINESS) (“YOU” OR “YOUR”) AND EATON, TOGETHER WITH ITS AFFILIATES AND SUBSIDIARIES. IN ACCESSING OR USING THE PRODUCT SOFTWARE, YOU AGREE TO BE BOUND BY THIS AGREEMENT. YOUR RIGHT TO USE THE PRODUCT SOFTWARE IS LIMITED BY APPLICABLE LAWS IN EACH JURISDICTION.

IF YOU DO NOT ACCEPT THE TERMS IN THIS AGREEMENT, DO NOT ACCESS OR USE THE PRODUCT SOFTWARE IN ANY WAY.

License. Subject to the terms and conditions of this Agreement, Eaton grants to you a limited, non-transferable, non-sublicensable, non-assignable, non-exclusive and revocable license to access and use the Product Software in conjunction with the operation of Eaton products to which the Product Software pertains or other products as described by Eaton in any user guides and manuals for access to and use of the Product Software (“**Documentation**”) solely for your own use and only in a manner that is consistent with the terms of this Agreement (“**License**”). In the event Eaton requires you to register as an end-user, this license is valid only if the registration is complete and accurate.

Restrictions. You are not allowed to copy, decompile, reverse engineer, disassemble, attempt to derive the source code of, modify, or create derivative works of the Product Software, or any updates or upgrades, or any part thereof. You may not use any part of the Product Software to create any independent data files, databases, compendiums or any other reference materials. If you breach these restrictions, you may be subject to prosecution and damages. The Product Software is intended for adults, and by accessing the Product Software, you represent that you are a legal adult.

Prohibited Conduct. In connection with your access to and/or use of the Product Software, you agree not to:

- Violate any laws or regulations.
- Make attempts to defeat or circumvent security features, or to use the Product Software for

- any purpose other than its intended purposes.
- Engage in any behavior that is designed to gain unauthorized access to protected areas of the Product Software and/or Eaton's computers, servers or networks, and/or any computers or systems used by other users of the Product Software.
 - Make unauthorized attempts to modify any information stored in the Product Software.
 - Use any automated technology such as a robot, spider, or scraper to access, scrape, or data mine the Product Software.
 - Provide false or misleading information when signing up for a Product Software account or otherwise upload/post any false or misleading information or content through the Product Software.
 - Upload/post anything that could destroy, damage, or impair any portion of the Product Software or any computers, systems, hardware, or software used by Eaton or other users.
 - Upload/post anything that imposes an unreasonable strain on Eaton's network or computer infrastructure.
 - Upload/post any unsolicited or unauthorized advertising, promotional materials, spam emails, chain letters, pyramid schemes, or any other form of such solicitations.

The previous list of prohibitions is not exclusive or exhaustive.

Updates. Eaton may update or upgrade the Product Software at any time. Certain functions of the Product Software may be modified or discontinued as a result of any such updates or upgrades. If Eaton elects to provide maintenance or support of any kind, Eaton may terminate that maintenance or support at any time without notice to you. The terms and conditions of this Agreement shall govern any upgrades or updates provided by Eaton that replace and/or supplement the original Product Software, unless such upgrade is accompanied by, or references, a separate license agreement in which case the terms of that license agreement shall govern.

Events Outside of Eaton's Control. Eaton will not be liable or responsible for any failure to perform, or delay in performance of, any of Eaton's obligations under this Agreement that is caused by any act or event beyond Eaton's reasonable control, including but not limited to, acts of God, failure of public or private telecommunications networks, changes in law or regulation, or any other force majeure event or circumstance, whether or not foreseeable.

Proprietary Rights. Eaton owns all rights, title and interest in, and to, without limitation, all intellectual and proprietary rights of any and all featured products or parts, including, but not limited to, any models, data, or formulas exhibited in the Product Software excluding any Open Source Software as defined below that may be contained herein. Except for the limited license granted to you herein, nothing in this Agreement shall be construed to restrict, transfer, convey, encumber, alter, impair or otherwise adversely affect Eaton's ownership or proprietary rights therein or any other of Eaton's information, processes, methodologies, products, goods, services, or materials, tangible or intangible, in any form and in any medium.

Open Source. Certain items of software included with the Product Software may be subject to "open source" or "free software" licenses ("**Open Source Software**"). Some of the Open Source Software is owned by third parties. The Open Source Software is not subject to the terms and conditions of this License. Instead, each item of Open Source Software is licensed under the terms and conditions accompanying such Open Source Software. Nothing in this Agreement limits your rights under or grants you rights that supersede the terms and conditions of any applicable end user license for the Open Source Software. To the extent there are any conflicts between the terms of this Agreement and any Open Source Software license corresponding to the open source component(s) of the software included with the Product Software or additional obligations by such Open Source Software license that are not set forth in this Agreement, the terms of the Open Source Software license will control. Eaton provides the Open Source Software to you "AS IS" without any indemnities or warranties of any kind.

Support Services. Eaton or its suppliers and distributors may provide you with support services related to the Product Software ("**Support Services**"). Use of Support Services is governed by the policies and programs described in the Documentation, and/or other Eaton-provided materials. Any supplemental materials provided to you as part of the Support Services shall be considered part of the Product Software, as applicable, and subject to the terms and conditions of this Agreement.

No Warranty. TO THE EXTENT PERMITTED BY LAW, YOU EXPRESSLY ACKNOWLEDGE AND AGREE THAT USE OF THE PRODUCT SOFTWARE IS AT YOUR SOLE RISK AND THAT THE ENTIRE RISK AS TO SATISFACTORY QUALITY, PERFORMANCE, ACCURACY AND EFFORT OF THE PRODUCT SOFTWARE IS WITH YOU. TO THE MAXIMUM EXTENT PERMITTED BY APPLICABLE LAW, THE PRODUCT SOFTWARE AND ANY SERVICES PERFORMED OR PROVIDED BY OR IN CONNECTION WITH THE PRODUCT SOFTWARE ARE PROVIDED ON AN "AS IS" AND "AS AVAILABLE" BASIS, WITH ALL BUGS AND FAULTS AND WITHOUT WARRANTY OF ANY KIND. EATON, ITS AFFILIATES, SUBSIDIARIES, AND AUTHORIZED REPRESENTATIVES HEREBY DISCLAIM ALL WARRANTIES AND CONDITIONS OF ANY KIND WITH RESPECT TO THE PRODUCT SOFTWARE AND ANY SERVICES, EITHER EXPRESS, IMPLIED, STATUTORY, OR OTHERWISE, INCLUDING, BUT WITHOUT LIMITATION, ANY IMPLIED WARRANTIES AND/OR CONDITIONS OF MERCHANTABILITY, OF SATISFACTORY QUALITY, OF FITNESS FOR A PARTICULAR PURPOSE, SECURITY, COMPLETENESS, TIMELINESS, ACCURACY, QUIET ENJOYMENT, TITLE, FREEDOM FROM COMPUTER VIRUSES, AND OF NON-INFRINGEMENT OF THIRD PARTY RIGHTS. NEITHER EATON, NOR ANY OF ITS AFFILIATES OR SUBSIDIARIES, WARRANT THAT THE FUNCTIONS OR SERVICES CONTAINED IN, ACCESSED FROM, PERFORMED BY, DISPLAYED ON, LINKED TO/FROM, OR PROVIDED BY, THE PRODUCT SOFTWARE WILL MEET YOUR REQUIREMENTS, THAT THE OPERATION OF THE PRODUCT SOFTWARE OR SERVICES WILL BE UNINTERRUPTED, ERROR-FREE, TIMELY, SECURE, OR THAT DEFECTS OR ERRORS IN THE PRODUCT SOFTWARE OR SERVICES WILL BE CORRECTED, OR THAT THE PRODUCT SOFTWARE WILL BE COMPATIBLE WITH ANY SYSTEM, OR THAT THE PRODUCT SOFTWARE WILL BE FREE FROM WORMS, VIRUSES, MALWARE, TROJAN HORSES, OR OTHER HARMFUL OR DISABLING COMPONENTS. NO ORAL OR WRITTEN INFORMATION OR ADVICE GIVEN BY EATON, ITS AFFILIATES, SUBSIDIARIES, OR ANY OF THEIR RESPECTIVE AUTHORIZED REPRESENTATIVES SHALL CREATE A WARRANTY. YOU ASSUME THE ENTIRE COST OF ANY AND ALL NECESSARY REPAIRS IN THE EVENT YOU EXPERIENCE ANY LOSS OR DAMAGE ARISING FROM THE USE OF THE PRODUCT SOFTWARE OR ANY RELATED GOODS OR SERVICES. IF YOU ARE DISSATISFIED WITH THIS AGREEMENT, THE PRODUCT SOFTWARE AND/OR ANY RELATED GOODS OR SERVICES, YOUR SOLE AND EXCLUSIVE REMEDY IS TO DISCONTINUE USING THE PRODUCT SOFTWARE. SOME JURISDICTIONS DO NOT ALLOW THE EXCLUSION OF IMPLIED WARRANTIES OR LIMITATIONS ON APPLICABLE STATUTORY RIGHTS OF A CONSUMER, SO THE ABOVE EXCLUSION AND LIMITATIONS MAY NOT APPLY TO YOU.

Limitation of Liability. TO THE EXTENT PERMITTED BY LAW, IN NO EVENT WILL EATON OR ITS OFFICERS, DIRECTORS, EMPLOYEES, AFFILIATES, SUBSIDIARIES AGENTS, LICENSORS, REPRESENTATIVES, ATTORNEYS AND/OR BUSINESS PARTNERS, NOR ANY PARTY INVOLVED IN THE CREATION, PRODUCTION, OR TRANSMISSION OF THE PRODUCT SOFTWARE, BE LIABLE FOR ANY LOSS OR DAMAGE OF ANY KIND WHATSOEVER, INCLUDING, BUT NOT LIMITED TO, ANY DIRECT, INDIRECT, INCIDENTAL, SPECIAL, STATUTORY, PUNITIVE, ACTUAL, LIQUIDATED, EXEMPLARY, CONSEQUENTIAL OR OTHER DAMAGES, INCLUDING, WITHOUT LIMITATION, DAMAGES FOR LOSS OF PROFITS, LOSS OF REVENUE, LOSS OF DATA, LOSS OF PRODUCTION, LOSS OF GOODWILL, INTELLECTUAL PROPERTY INFRINGEMENT, BUSINESS INTERRUPTION OR LOSS OF USE, PAIN AND SUFFERING, EMOTIONAL DISTRESS OR SIMILAR DAMAGES, OR ANY OTHER COMMERCIAL DAMAGES OR LOSSES, ARISING OUT OF OR RELATED TO YOUR USE OR INABILITY TO USE

THE PRODUCT SOFTWARE, HOWEVER CAUSED, REGARDLESS OF THE THEORY OF LIABILITY (CONTRACT, TORT OR OTHERWISE) AND EVEN IF EATON OR THE AFOREMENTIONED PARTIES HAVE BEEN ADVISED OF THE POSSIBILITY OF SUCH DAMAGES.

TO THE EXTENT PERMITTED BY LAW, IN NO EVENT WILL THE COLLECTIVE LIABILITY OF EATON OR THE AFOREMENTIONED PARTIES, REGARDLESS OF THE TYPE OF ACTION, WHETHER IN CONTRACT, TORT, OR OTHERWISE, EXCEED THE GREATER OF \$100.00 OR THE AMOUNT THE AUTHORIZED PARTY PAID TO EATON AND/OR THE AFOREMENTIONED PARTIES FOR THE APPLICABLE GOODS OR SERVICES OUT OF WHICH THE LIABILITY AROSE.

Indemnification. You agree to indemnify, defend, and hold harmless Eaton, including its officers, directors, employees, affiliates, subsidiaries, agents, licensors, representatives, attorneys, business partners, and respective successors and assigns (“**Indemnified Parties**”) from and against any and all claims, demands, actions, liabilities, judgments, awards, losses, damages, costs and expenses (including reasonable attorneys’ fees, costs of defense, and direct, indirect, punitive, special, individual, consequential, or exemplary damages), Eaton or any of the Indemnified Parties suffer in relation to, arising from, or from the purpose of avoiding, any claim or demand from a third party that relates to your: (a) breach or violation of this Agreement; (b) infringement, misappropriation or any violation of the rights of any other party from use of the Product Software in violation of this Agreement; (c) violation or non-compliance with any applicable law, rule, guidelines, acts, decrees, orders or regulations; (d) use, alteration or export of the Product Software (or any component thereof) in violation of this Agreement; and (e) the use of the Product Software by you or any person using your account. Eaton and its affiliates reserve the right to assume the exclusive defense and control of any claims or actions subject to indemnification by you and all negotiations for its settlement or compromise, and you agree to fully cooperate with Eaton and its affiliates upon request by Eaton.

By accepting this Agreement, you waive and hold harmless Eaton from any claims resulting from any action taken by Eaton during or as a result of Eaton’s investigation and/or from any actions taken as a consequence of investigations by either Eaton or law enforcement related to your use of the Product Software.

Amendments to this Agreement. Eaton may modify, add or remove any of the terms and conditions of this Agreement at its sole discretion at any time without prior notice. Your continued use of the Product Software after such modifications are made to the Agreement will mean that you accept and agree to be bound by and comply with such changes and updates.

For Authorized Parties in California. In compliance with California Civil Code § 1789.3, an Authorized Party residing in California has the right to contact Eaton with any complaints or to seek additional information. Such Authorized Party may email Eaton at dataprotection@eaton.com or write to: Attn: Global Data Protection and Privacy Office, Eaton, 1000 Eaton Blvd., Cleveland, OH 44122.

If Authorized Parties in California have any questions or complaints about Eaton they may also contact: The Complaint Assistance Unit of the Division of Consumer Services of the California Department of Consumer Affairs through writing at 400 R Street, Suite 1080, Sacramento, CA 95814, or by telephone at (916) 445-1254 or (800) 952-5210. Hearing impaired persons may call (916) 928-1227 or (800) 326-2297 via TTY device.

Confidential Information. All information provided in Product Software is Eaton’s confidential information. You agree that you will not use or disclose Eaton’s confidential information without the prior written consent of Eaton, except to share it with your employees who have a need to know the information and are bound by a duty of confidentiality covering the information that is at least as restrictive as the obligations in this Agreement.

Except for personally identifiable information, the use and disclosure of which is addressed in the Privacy Policy for the Product Software, any and all information and content provided by you to Eaton is provided on a non-proprietary and non-confidential basis, regardless of whether the information or content is marked or otherwise identified as confidential or proprietary. You agree that Eaton has a royalty-free, perpetual, irrevocable, worldwide, non-exclusive right and license to use, reproduce, modify, adapt, publish, translate, create derivative works from, distribute, perform, and display any provided information or content for the purpose of operating and/or marketing the Services or any related services rendered by Eaton. This license includes any right of publicity rights that may be present in the provided information or content.

Intellectual Property. Other than the exceptions referenced in this Agreement and noted elsewhere, all content provided through the Product Software is the sole and exclusive property of Eaton including, but not limited to, all trade names, service marks, trademarks, logos, text, data, documents, messages, pictures, images, video, audio, graphics, links, software and its underlying code, domain names, or other electronic files (referred to hereafter as “**Eaton Content**”).

Certain elements of the Product Software including, but not limited to, text, graphics, photos, images, video, audio, color selections, organization and layout, are copyright protected under United States and international copyright laws. Any Eaton Content protected by intellectual property laws may not be copied, republished, posted, modified, edited, transmitted, distributed, used to create derivative works of, or reverse engineered without Eaton’s written permission. No information, data, documents, or records found through the Product Software shall be made available as part of a website, app or online location, whether by hyperlink, framing on the internet or otherwise, without the express written consent of Eaton.

You acknowledge that you have no right, title or interest in or to the Product Software and/or any Eaton Content. EATON is a trade name and/or marks owned exclusively by Eaton. You shall not use any trade names or marks that are confusingly similar in Eaton’s sole opinion without the prior written consent of Eaton, which may be withheld in its sole discretion. Nothing in this Agreement and nothing found through the Product Software shall be construed as a license to use any of Eaton’s trademarks, patents, copyrights, or other intellectual property rights.

There may be other content located in the Product Software that is not owned by Eaton, and you should respect those property rights as well. All rights not expressly granted herein are reserved to Eaton.

Termination or Suspension. This Agreement is effective for an unlimited duration unless and until terminated as set forth herein. Eaton reserves the right to terminate your access to the Product Software for any violation of this Agreement, and in those circumstances, all rights under the license granted shall terminate automatically without notice from Eaton. If Eaton suspends or terminates your account under this Agreement, you acknowledge that all information and content associated with such account will no longer be available to you. Upon termination of this Agreement, you shall cease all use of the Product Software, and destroy all copies, full or partial, thereof. Any provision of this Agreement which by its nature must survive the termination of this Agreement in order to give effect to its meaning shall survive such termination.

Miscellaneous. If any provision hereof becomes or is declared by a court of competent jurisdiction to be illegal, unenforceable, or void, this Agreement will continue in full force and effect without said provision. The section titles in this Agreement are for convenience only and have no legal or contractual effect. No failure or delay by Eaton or its affiliates to exercise any right or enforce any obligation shall impair or be construed as a waiver or ongoing waiver of that or any other right or power. Waiving one breach will not be construed to waive any succeeding breach. All waivers must be in writing and signed by the party waiving rights. No provisions in purchase orders, or in any other business forms employed by you, will supersede the terms and conditions of this Agreement.

Export Rules and U.S. Government Restricted Rights. You agree not to provide access to or use of the Product Software to any citizen of a country to which access or use thereof is barred, or to which exports or shipments are barred, or to anyone on the U.S. Treasury Department's list of Specially Designated National or the U.S. Department of Commerce Denied Person's List or Entity List or any other restricted parties lists by the United States government. Further, you will not shop, transfer or export the Product Software into any country or use the Product Software in any manner prohibited by the United States Export Administration Act or any other export laws, restrictions or regulations (collectively the "**Export Laws**"). In addition, if the Product Software is identified as export controlled items under the Export Laws, you represent and warrant that you are not a citizen of, or otherwise located within, an embargoed nation and that you are not otherwise prohibited under the Export Laws from receiving access to or using the Product Software. All rights to access and use of the Product Software are granted on condition that such rights are forfeited if you fail to comply with the terms of this Agreement.

If the Software is licensed to agencies of the U.S. Government, the Software is a "commercial item" as that term is defined at 48 C.F.R. § 2.101, consisting of "commercial computer software" and "commercial computer software documentation", as such terms are used in 48 C.F.R. § 12.212, and is provided to the U.S. Government only as a commercial end item. Consistent with 48 C.F.R. § 12.212 and 48 C.F.R. §§ 227.7202-1 through 227.7202-4, all U.S. Government End Users acquire the Software with only those rights set forth herein. Contractor/manufacturer is Eaton Corporation, 1000 Eaton Boulevard, Cleveland, Ohio 44122.

Compliance with License and Laws. You shall comply with all federal, state, local and foreign laws, regulations, rules and ordinances pertaining to the license granted to you under this Agreement. If any part of this Agreement is determined to violate any applicable federal, state, local or foreign laws, rules or regulations, then the remaining provisions of this Agreement shall remain in full force and effect and shall be enforced to fullest extent permitted by law.

Governing Law and Interpretation. To the extent not prohibited by law, you agree that this Agreement and all disputes, claims, actions, suits or other proceedings arising hereunder shall be governed by, and construed in accordance with, the substantive law of the State of Ohio applicable to contracts wholly made and to be performed within the State of Ohio, and to irrevocably submit to the sole and exclusive jurisdiction of the courts of Ohio or the Federal courts of the Northern District of Ohio, and to irrevocably consent to the exercise of personal jurisdiction by such courts and waive any right to plead, claim or allege that Ohio is an inconvenient forum.

Agreement. This Agreement constitutes the entire agreement between you and Eaton regarding the use of the Product Software and supersedes any prior or contemporaneous understandings and agreements between you and Eaton related to its subject matter.

If you have any questions regarding this Agreement, you may contact Eaton at:

Eaton
Attn: Law Department
1000 Eaton Boulevard
Mail Code 4N
Cleveland, OH 44122
Email: cyberlawteam@eaton.com

Eaton
Attn: Global Data Protection and Privacy Office
1000 Eaton Boulevard

Cleveland, OH 44122

Email: dataprotection@eaton.com

EATON SC300 CYBERSECURITY RECOMMENDATIONS

The SC300 has been designed with cybersecurity as an important consideration. A number of features are offered in the product to address cybersecurity risks. These Cybersecurity Recommendations provide information to help users to deploy and maintain the product in a manner that minimizes the cybersecurity risks. These Cybersecurity Recommendations are not intended to provide a comprehensive guide to cybersecurity, but rather to complement customers' existing cybersecurity programs.

Eaton is committed to minimizing the cybersecurity risk in its products and deploying cybersecurity best practices in its products and solutions, making them more secure, reliable and competitive for customers.

The following Eaton whitepapers are available for more information on general cybersecurity best practices and guidelines:

Cybersecurity Considerations for Electrical Distribution Systems (WP152002EN):

http://www.eaton.com/ecm/groups/public/@pub/@eaton/@corp/documents/content/pct_1603172.pdf

Cybersecurity Best Practices Checklist Reminder (WP910003EN):

http://www.cooperindustries.com/content/dam/public/powersystems/resources/library/1100_EAS/WP910003EN.pdf

Category	Description
Asset Management	<p>Keeping track of all devices in your network is a pre-requisite for effectively managing cybersecurity. Eaton recommends that you maintain an asset inventory that uniquely identifies each important component. To facilitate this, the SC300 supports the following identifying information:</p> <p>Product Hardware / Identity These are found in the web / DCTools System Identification > Identity page.</p> <ul style="list-style-type: none"> • Product Type • Hardware version • LCD version • Serial Number • Ethernet MAC address • Manufacturer Name <p>Firmware This is found in the web / DCTools System Identification > Software page.</p> <ul style="list-style-type: none"> • Core application revision <p>Communications This is found in the web / DCTools System > Interfaces > Physical Ports > Ethernet</p> <ul style="list-style-type: none"> • IP address <p>System information This is entered by the system manufacturer. These are found in the web / DCTools System Identification > Identity page. Location and site information are also available.</p> <ul style="list-style-type: none"> • System Manufacturer • System Type • System Serial number • Configuration Name <p><i>All the above information is also available using SNMP.</i></p>
Risk Assessment	<p>Eaton recommends conducting a risk assessment to identify and assess reasonably foreseeable internal and external risks to the confidentiality, availability and integrity of the system device and its environment. This exercise should be conducted in accordance with applicable technical and regulatory frameworks such as IEC 62443 and NERC-CIP. The risk assessment should be repeated periodically.</p>
Physical Security	<p>An attacker with unauthorized physical access can cause serious disruption to system or device functionality. Additionally, Industrial Control Protocols don't offer cryptographic protections, making ICS and SCADA communications especially vulnerable to threats to their confidentiality. Physical security is an important layer of defense in such cases. The SC300 is designed to be deployed and operated in a physically secure location. Following are some best practices that Eaton recommends to physically secure the SC300:</p> <ul style="list-style-type: none"> - Secure the facility and equipment rooms or closets with access control mechanisms such as locks, entry card readers, guards, man traps, CCTV, etc. as appropriate. - Restrict physical access to cabinets and/or enclosures containing the SC300 and the associated system. Monitor and log the access at all times. - Physical access to the telecommunication lines and network cabling should be restricted to protect against attempts to intercept or sabotage communications. It's a best practice to use metal conduits for the network cabling running between equipment cabinets.

Category	Description
	<ul style="list-style-type: none"> - The SC300 supports the following physical access ports: - Ethernet 100baseT - USB micro (AB) - RS-485 <p>Access to these ports should be restricted.</p> <ul style="list-style-type: none"> - Do not connect removable media (e.g., USB devices) for any operation (e.g., firmware upgrade, configuration change, or boot application change) unless the origin of the media is known and trusted.
Time Synchronization	<p>For accurate logging of events and time-based control, where applicable, an accurate internal clock is needed.</p> <ul style="list-style-type: none"> - Ensure the SC300 clock is synchronized with an authoritative time source (using manual configuration or SNTP).
Network Security	<p>The SC300 supports network communication with other devices in the environment. This capability can present risks if it's not configured securely. Following are Eaton recommended best practices to help secure the network. Additional information about various network protection strategies is available in <i>Eaton Cybersecurity Considerations for Electrical Distribution Systems [R1]</i>.</p> <p>Eaton recommends segmentation of networks into logical enclaves, denying traffic between segments except that which is specifically allowed, and restricting communication to host-to-host paths (for example, using router ACLs and firewall rules). This helps to protect sensitive information and critical services and creates additional barriers in the event of a network perimeter breach.</p> <p>Communication Protection: The SC300 provides the option to encrypt its network communications. Please ensure that encryption options are enabled. You can secure the product's communication capabilities by taking the following steps:</p> <ol style="list-style-type: none"> 1. https Use https for web communications wherever possible. https access can be locked out in the SC300 from System > Interfaces > Remote Access Protocols > http (web). 2. SNMP V3 Use SNMP V3 with authorization and encryption options. 3. S3P (used by DCTools and PowerManagerII) does not have an encryption option and should be disabled from System > Interfaces > Remote Access Protocols > S3P. 4. Modbus TCP does not have an encryption option and should be disabled from System > Interfaces > Remote Access Protocols > Modbus. <p>Eaton recommends opening only those ports that are required for operations and protect the network communication using network protection systems like firewalls and intrusion detection systems / intrusion prevention systems. Use the information below to configure your firewall rules to allow access needed for the SC300 to operate smoothly.</p> <p>The SC300 requires access to the following ports, where applicable:</p> <ul style="list-style-type: none"> • Web server (https): ports 8443 and 443 • Web server (http – factory reset state only): ports 80 and 8080 • SNMP: ports 161 and 162 • SNTP client: port 123 • Email (SMTP) notifications: port 25 • Modbus-TCP: port 502 • S3P (DCTools and PM2): 14000 • RADIUS Authentication: ports 1812/1813/2083

Category	Description
Secure passwords	<p>After login with the default password, the SC300 will prompt the user to create a new user with a complex password.</p> <p>Please change the default user name and password to a new user name and password immediately after login.</p> <p><i>Note that the SC300 includes validation rules to ensure passwords are secure.</i></p>
Logging and Event Management	<ul style="list-style-type: none"> - Eaton recommends logging all relevant system and application events, including all administrative and maintenance activities. - Logs should be protected from tampering and other risks to their integrity (for example, by restricting permissions to access and modify logs, transmitting logs to a security information and event management system, etc.). - Ensure that logs are retained for a reasonable and appropriate length of time. - Review the logs regularly. The frequency of review should be reasonable, taking into account the sensitivity and criticality of the system device and any data it processes. <p>The SC300 maintains an Event log that records system events such as:</p> <ul style="list-style-type: none"> • Configuration changes • Start-up • Login success / Fail / Authorization fail, Authorization success • RADIUS login attempt, login fail <p>This log should be regularly downloaded and stored for later access.</p>
Malware Defenses	<p>Eaton recommends deploying adequate malware defenses to protect the product or the platforms used to run the Eaton product.</p>
Secure Maintenance	<p>Best Practices</p> <p>Update device firmware prior to putting the device into production. Thereafter, apply firmware updates and software patches regularly.</p> <p> Eaton publishes patches and updates for its products to protect them against vulnerabilities that are discovered. Eaton encourages customers to maintain a consistent process to promptly monitor for and install new firmware updates.</p> <ul style="list-style-type: none"> - Please contact your Eaton supplier for firmware upgrades. <p>Please check Eaton's cybersecurity website for information bulletins about available firmware and software updates.</p> <p>https://www.eaton.com/us/en-us/company/news-insights/cybersecurity.html</p>
Business Continuity / Cybersecurity Disaster Recovery	<p>Plan for Business Continuity / Cybersecurity Disaster Recovery</p> <p>Eaton recommends incorporating the SC300 into the organization's business continuity and disaster recovery plans. Organizations should establish a Business Continuity Plan and a Disaster Recovery Plan and should periodically review and, where possible, exercise these plans. As part of the plan, important system device data should be backed up and securely stored, including:</p> <ul style="list-style-type: none"> - Updated firmware for the SC300. Make it a part of standard operating procedure to update the backup copy as soon as the latest firmware is updated. - The current configuration file or snapshot file for each SC300, with the software version, appropriate site name and IP address identified. - A snapshot file includes all the IP address and access information. - If a configuration file is saved, then addresses, users and passwords will need to be manually

Category	Description
	<p>entered.</p> <ul style="list-style-type: none"> - Documentation of the current users and passwords, along with their access rights. <ul style="list-style-type: none"> • SC300 failure is indicated typically by a blank screen and / or permanent loss of communications • A failed SC300 may be replaced by any SC300 of the same or later software version. • The snapshot file or configuration file appropriate to the site should be reloaded before or after installation.
Sensitive Information Disclosure	<p>Eaton recommends that sensitive information that may be stored by the SC300 be adequately protected through the deployment of organizational security practices.</p> <p>Examples:</p> <ul style="list-style-type: none"> • Email addresses (used by email alarm notification) • Contact information (in Identity).

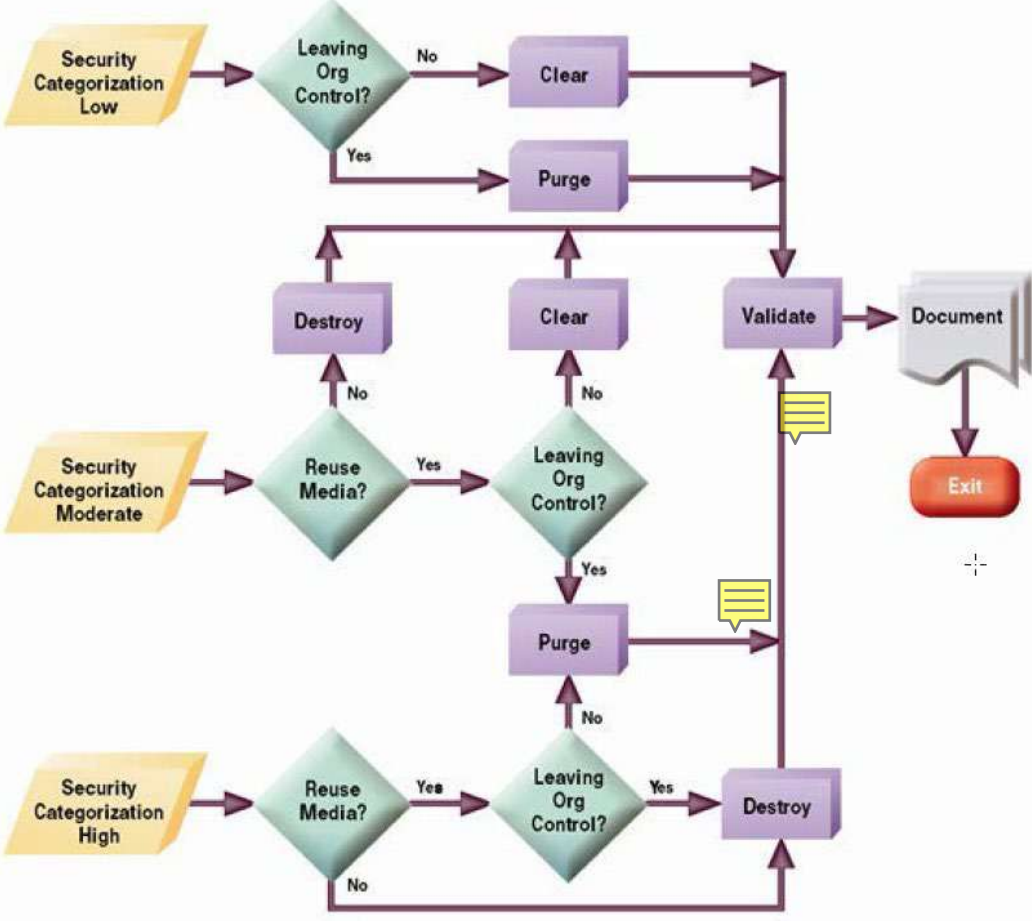
Category	Description
Decommissioning or Zeroisation	<p>It is a best practice to purge data before disposing of any device containing data. Guidelines for decommissioning are provided in NIST SP 800-88. Eaton recommends that products containing embedded flash memory be securely destroyed to ensure data is unrecoverable.</p>  <p style="text-align: center;">* Figure and data from NIST SP800-88</p> <ul style="list-style-type: none"> - <u>Embedded Flash Memory on Boards and Devices</u> - Eaton recommends the following methods for disposing of the SC300 flash memory <ul style="list-style-type: none"> - Clear: Reset the state to original factory settings. Using web access, go to Identity > Software and set <i>Generic System Type</i> to Factory. - Destroy: Shred, disintegrate, pulverize, or Incinerate by burning the device in a licensed incinerator.

References

[R1] *Cybersecurity Considerations for Electrical Distribution Systems (WP152002EN)*:

http://www.eaton.com/ecm/groups/public/@pub/@eaton/@corp/documents/content/pct_1603172.pdf

[R2] *Cybersecurity Best Practices Checklist Reminder (WP910003EN)*:

http://www.cooperindustries.com/content/dam/public/powersystems/resources/library/1100_EAS/WP910003EN.pdf

[R3] *NIST SP 800-82 Rev 2, Guide to Industrial Control Systems (ICS) Security, May 2015*:

<https://ics-cert.us-cert.gov/Standards-and-References>

[R4] *National Institute of Technology (NIST) Interagency "Guidelines on Firewalls and Firewall Policy, NIST Special Publication 800-41", October 2009*:

<http://nvlpubs.nist.gov/nistpubs/Legacy/SP/nistspecialpublication800-41r1.pdf>

[R5] *NIST SP 800-88, Guidelines for Media Sanitization, September 2006*:

http://ws680.nist.gov/publication/get_pdf.cfm?pub_id=50819

EQUIPMENT INCIDENT REPORT

Please enter as much information as you can. Send the completed form, together with the item for repair to your nearest authorized service agent. NOTE: Only one fault to be recorded per form.
For further information contact your local Eaton dc product supplier or Eaton (see contact details on page 159).

Date: _____

Customer Information

Company: _____

Postal Address: _____

Return Address: _____
(Not PO Box) _____

Telephone: _____ Fax: _____ Email: _____

Contact Name: _____

Location of Failure

Product code: _____ Serial number: _____ Document number: _____

System type installed in: _____ Serial number: _____

Site name or location: _____

Fault discovered	<input type="checkbox"/> Delivery	<input type="checkbox"/> Unpacking	<input type="checkbox"/> Installation
	<input type="checkbox"/> Initial test	<input type="checkbox"/> Operation after _____ years	<input type="checkbox"/> Other _____
Failure source	<input type="checkbox"/> Design	<input type="checkbox"/> Manufacturing	<input type="checkbox"/> Documentation
	<input type="checkbox"/> Transportation	<input type="checkbox"/> Installation	<input type="checkbox"/> Handling
	<input type="checkbox"/> _____		

Effect on system operation None Minor Major _____

INFORMATION (fault details, circumstances, consequences, actions)

Internal use only.

Reference No: _____ RMA: _____ NCR: _____ Signature: _____ Date: _____

INFORMATION continued (fault details, circumstances, consequences, actions)

Lined area for notes or text.

SG/03 ISS06

For product information and a complete listing of worldwide sales offices, visit Eaton's website at: dcpower.eaton.com or email: DCinfo@eaton.com

?

??? on SC300 Display • 13, 118

A

A/B systems • 99
AC Alarm Thresholds • 54, 55
AC Phase 1/2/3 Voltage • 127
AC Rectifier Current Limit • 40
AC Supply
 AC Fail Alarm • 54, 86, 127
 AC Low and AC High Alarms • 64
 AC Phase Alarm • 127
 AC Voltage • 39, 55, 81
 ACD Fan Fail Alarm • 86, 127, 139
ACD Fan Fail Alarm • 86, 127, 139
Active Voltage Control • 27, 29
Ah Discharged • 34, 65, 73
Alarms • 52
 Alarm Configuration • 52, 54
 Alarm Descriptions • 127
 Alarm Inhibiting • 55
 Alarm Tracking • 54, 55
 Analog Input Alarms • 52, 83
 Audible Alarm Indication • 13, 52
 Digital Input Alarms • 52, 86
 LEDs (SC300) • 1, 13, 117
 LVD Status LED • 2, 120
 Mappings • 139
 Monitor OK Alarm • 2, 118
 Rectifier Alarms • 127
 Rectifier Comms Lost Alarm • 42, 129
 Relays • See Digital Outputs (Relays)
 SC300 Alarms • 13, 52, 117
 Severity • 52
 Smart Alarms • 57
 Sound • See Audible Alarm Indication
 System Alarms • 52, 127
 System Overload Alarm • 54, 56, 130
All Logs • 95
Alternative Energy Input Metering • 89
Analog Inputs • 13, 83, 84

Analog Input Alarms • 52, 83
 Mappings • 139
Audible Alarm Indication • 13, 52
Audit log • 95
AVC • See Active Voltage Control

B

Battery • 65
 Ah Discharged • 34, 65, 73
 Battery Capacity • 65
 Battery Charge State • 65
 Battery Current • 13, 81, 84, 118, 139
 Battery Current Sensor Fail • 65
 Battery Fuse Fail Alarm • 86, 127, 139
 Battery Fuses • 122
 Battery Temperature • 13, 35, 65, 84
 Battery Temperature High Alarm • 54, 127
 Battery Temperature Low Alarm • 54, 127
 Battery Test • 27, 29, 31, 33, 35
 Battery Test Alarms • 127
 Cells Per String • 35, 65
 CellSure • 113
 Equalize • 27, 31, 32
 Fast Charge • 27, 31, 33
 In Discharge Alarm • 128
 Mid-Point Monitoring (MPM) • 67
 Number of Cells • See Cells Per String
 Reverse Polarity • 74, 130
 String Fail Alarm • 67, 120, 130
 Temperature Compensation • 27, 35
 Temperature Sensor • 2, 4, 81, 124, 139
 Time Remaining • 65, 66, 70
Battery Circuit Breakers • 122
 Battery Fuse Fail Alarm • 86, 127, 139
Battery Current Limit (BCL) • 27, 29, 33
 Battery Current Limit Alarm • 127
 Engine Run BCL • 29
Battery Symmetry Monitoring • 123
Battery Symmetry Monitoring Log • 95
Battery Test Cancelled • 127
Battery Test Fail • 127
BCL • See Battery Current Limit (BCL)
Browsers (recommended) • 4

Bus Voltage • 81
 Bus Voltage Sense • 2, 29, 139
 High Load Alarm • 54, 128
 Low Load Alarm • 54, 128
 Bus Voltage Sense Input • 125

C

Cabinet Fan Fail Alarm • 127
 Cells Per String • 35, 65
 CellSure • 113
 Characterization • 47
 Characterization Data Management • 73
 Characterization of LVD • 48
 Circuit Breakers
 Battery Circuit Breakers • 122
 Battery Fuse Fail Alarm • 86, 127, 139
 Load Circuit Breakers • 121
 Load Fuse Fail Alarm • 86, 128, 139
 Communications • 101, 123
 Browsers (recommended) • 4
 Communications Options • 101
 Connector • 1, 4
 DCTools • 4, 14, 101, 111
 Ethernet Communications • 101, 119
 GSM Modem Communications • 111, 118
 HTTP/HTTPS • 115
 Loss of Communications • 114
 MAC Address • 101
 Modbus • 109
 PSTN Modem Communications • 118
 Security • 114
 Serial Server • 113
 SNMP • 106
 USB Communications • 14, 120
 Web Access Security • 115, 119
 Web Server • 104, 119
 Write Access Password • 114, 119
 Configuration Error • 127
 Configuration File • 25, 52
 Backup and Restore • 25
 Changing a Configuration Setting • 11
 Contactor Configuration • 51
 Contrast • See Display Settings
 Control • See Voltage Control
 Current

Battery Current • 13, 81, 84, 118, 139
 Load Current • 13, 81, 84, 118
 No Load Alarm • 129
 Rectifier Current • 7, 13, 81, 84
 Current Limit
 Battery Current Limit (BCL) • 27, 29, 33
 Rectifier Current Limit • 40
 Current Sense • 2, 4, 81, 124, 139

D

Data and Events Log • 94, 95
 Data Logging • 94
 Data Log • 94
 Event Log • 94
 System Event Types • 137
Data Min/Max Log • 94
 DC Input Fail • 128
 DC/DC control • 99
 DCDC Fail • 128
 DCTools • 4, 14, 101, 111
 N/A (in DCTools/Web) • 118
 Software Versions • 4
 Write Access Password • 114, 119
 Digital Input Alarms • 87
 Digital Inputs • 86, 124, 139
 Connectors • 2, 4, 87, 89, 132
 Digital Input Alarms • 52, 86
 Mappings • 139
 System States • 86
 Digital Outputs (Relays) • 52, 88, 123
 Connectors • 2, 4, 87, 89, 132
 Relay Mapping • 54, 86, 88, 141
 Remote Control State • 88
 Test Digital Outputs • 88
 Display Settings • 12
 Language • 24
 DO Manual • 128

E

EATON SC300 CYBERSECURITY
 RECOMMENDATIONS • 149
 Email Alarm Messages • 108, 112
END-USER LICENSE AGREEMENT • 142
 Energy Log • 94, 95
 Energy Metering • 89

Engine Run BCL • 29
Equalize • 27, 31, 32
 Equalize Active Alarm • 128
Ethernet
 Connector • 1, 4
 Ethernet Communications • 101, 119
 MAC Address • 101
 Problems • See Troubleshooting
Event Log • 94
 System Event Types • 137

F

Factory • 18
Fan Controller • 83, 92, 93
Fan Controller Log • 95
Fast Charge • 27, 31, 33
 Fast Charge Active Alarm • 128
Float Voltage • 27, 28, 29, 39, 55
 High Float Alarm • 54, 128
 Low Batt Temp Alarm • 54, 128
Function • 86
Fuse
 Battery Fuses • 122
 Load Fuses • 121

G

Generator
 Fuel Management • 78
 Generator Control • 75
 Generator Fail Alarm • 54, 75, 128
Generic System Types • 17
GSM Modem Communications • 111, 118

H

Heatsink Temperature • 39, 55
High Float Alarm • 54, 128
High Load Alarm • 54, 128
Horizontal/Vertical Setting of Display • See
 Display Settings
HTTP/HTTPS • 115
Hybrid Power System • 35, 77

I

Identify a Rectifier • 42
Identify an I/O Board • 79

Identity Information • 15, 25
In Discharge Alarm • 128
Input/Output (I/O) Board
 Additional I/O • See SiteSure-3G I/O module
 Analog Inputs • 13, 83, 84
 Connections to other system components • 4
 Connector Pin-outs • 87, 89, 132
 Description • 2
 Digital Inputs • 86, 124, 139
 I/O Board Mapping • 139
 Identify an I/O Board • 79
 LVD Status LED • 2, 120
 Power On LED • 2, 120
 Repair and Return • 156
 Replacing the Input/Output Board • 122
Internal Clock • 18, 120
Internal clock battery • 20
IOB Comms Lost • 128
IOBGP I/O Board • 123

K

Keypad
 Keypad Access Security • 12, 118

L

Language • 24
Latched contactors • 46
LCD • 8, 117
 Display Settings • 12
 Language • 24
LEDs
 LEDs (SC300) • 1, 13, 117
 LVD Status LED • 2, 120
 Power On LED • 2, 120
 Troubleshooting • 117
Load Circuit Breakers • 121
 Load Fuse Fail Alarm • 86, 128, 139
Load Current • 13, 81, 84, 118
Load Fuse Fail Alarm • 86, 128, 139
Load Fuses • 121
Load Power • 13, 81, 84
Load-Based Rectifier Shutdown • 44
Locate Rectifier • See Identify a Rectifier
Log • See Data Logging
Log Sizes • 96

Log Storage • 96
 Logon (SC300) • 12
 Logon ID (Web) • 115
 Low Batt Temp Alarm • 54, 128
 Low Load Alarm • 54, 128
 Low Voltage Disconnect (IOBGP) • 125
 Low Voltage Disconnect (LVD XE "LVD") • 45
 Low Voltage Disconnect (LVD)
 Connectors • 2, 4
 LVD Status LED • 2
 Low Voltage Disconnect (LVD) • 48
 Low Voltage Disconnect (LVD)
 Characterization of LVD • 48
 Low Voltage Disconnect (LVD)
 Connectors • 87
 Low Voltage Disconnect (LVD)
 Connectors • 89
 Low Voltage Disconnect (LVD)
 Connectors • 89
 Low Voltage Disconnect (LVD)
 Problems • 120
 Low Voltage Disconnect (LVD)
 LVD Status LED • 120
 Low Voltage Disconnect (LVD)
 LVD Alarms • 128
 Low Voltage Disconnect (LVD)
 Connectors • 132
 Low Voltage Disconnect (LVD)
 Mappings • 139
 Low Voltage Disconnect (LVD)
 LVD Alarms • See Troubleshooting
 LVD • 45, See Low Voltage Disconnect (LVD)
 LVD Configuration • 50
 LVD contactor(s) not operating. • 121
 LVD Disconnected • 128
 LVD Fail • 128
 LVD Manual • 128
 LVD Setup • 49

M

MAC Address • 101, 102
 Main Screen • 7, 13, 84
 Main Screen Items • 13, 84
 Mains Fail Alarm • See AC Fail Alarm
 Manual Rectifier / Solar Shutdown • 42

Manual Sources • 64
 Mappings • 139
 Mid-Point Monitoring (MPM) • 67
 String Fail Alarm • 67, 120, 130
 Modbus • 109
 Modem (PSTN, GSM) • See Communications
 Monitor OK Alarm • 2, 118
 MOVs
 MOV Fail Alarm • 86, 128, 139
 MPM • See Mid-Point Monitoring (MPM)
 Multiple Rectifier Comms Lost Alarm • 128
 Multiple Rectifier Fail Alarm • 129
Multiple Solar Comms Lost • 129

N

N/A (in DCTools/Web) • 118
 Network Management System (NMS) • See
 SNMP
 No Load Alarm • 129
Normal Charge • 129
 Number of Cells • See Cells Per String

O

Output Voltage and Current • 27, 39, 55, 81
 Over Voltage Shut Down (OVSD) • 40

P

Partial AC Fail Alarm • 129
 Password
 Web Access Security • 115, 119
 Write Access Password • 114, 119
 PC/Laptop (Connection via USB) • See USB
 Communications
Peak Load Reduction • 129
 Peak Load Reduction (PLR) • 36
 Phase Detection • 41
 Polarity
 Reverse Polarity • 74, 130
 Power
 Load Power • 13, 81, 84
 System Power • 13, 81, 84
 Power and RXP Comms • 125
 PowerManagerII • 4, 52
 PowerManagerII Communications Setup • 104
 Protection • See Security

PSTN Modem Communications • 118

Q

QPM • 67

Quarter-point monitoring • 67

R

Ramp Up Slope • 40

Raw log binary • 95

Rectifier Current Limit • 129

Rectifier Fail • 129

Rectifier OverTemperature • 129

Rectifiers

AC Rectifier Current Limit • 40

Heatsink Temperature • 39, 55

Identify a Rectifier • 42

Load Power • 13, 81, 84

Load-Based Rectifier Shutdown • 44

Locate Rectifier • See Identify a Rectifier

Output Voltage and Current • 27, 39, 55, 81

Over Voltage Shut Down (OVSD) • 40

Problems • See Troubleshooting

Ramp Up Slope • 40

Rectifier Alarms • 127

Rectifier Comms Lost Alarm • 42, 129

Rectifier Current • 7, 13, 81, 84

Rectifier Current Limit • 40

Registration • 39, 55

Repair and Return • 156

Restart Rectifier(s) • 43

Serial Number • 39, 42, 55

Shutdown • 40, 42, 118

Start Up Delay • 40

System Overload Alarm • 54, 56, 130

System Power • 13, 81, 84

Voltage Control • 27

Redundancy • 44

Relays • See Digital Outputs (Relays)

Monitor OK Alarm • 2, 118

Relay Mapping • 54, 86, 88, 141

Remote Control State • 88

Repair and Return • 156

Reset Battery State • 73

Restart Rectifier(s) • 43

Reverse Polarity • 74, 130

RIP Comms Lost • 129

RS232 • 111

Connector • 1, 4

Modem (PSTN, GSM) • See Communications

Serial Server • 113

S

SC200 system controller

Alarm Descriptions • 127

Repair and Return • 156

SC300 system controller

??? on SC300 Display • 13, 118

Changing a Configuration Setting • 11

Configuration File • 25, 52

Connections to other system components • 4

Connector Pin-outs • 87, 89, 131, 132

Description • 1

Display Settings • 12

Firmware Upgrade • 24

Identity Information • 15, 25

Internal Clock • 18, 120

Keypad • 8, 118

Language • 24

LEDs (SC300) • 1, 13, 117

Main Menu • 9

Main Screen • 7, 13, 84

Mappings • 139

N/A (in DCTools/Web) • 118

Problems • See Troubleshooting

Replacing the System Controller • 122

SC300 Alarms • 13, 52, 117

Security • See Keypad Access Security

Startup • 7

Schedule Sources • 61

Scheduled Sources Operation • 62

Security • 114

Keypad Access Security • 12, 118

Web Access Security • 115, 119

Write Access Password • 114, 119

Sensor Fail Alarm • 129

Serial Communications (USB / RS-232) Security • 114

Serial Server • 113

Servicing • 156, 159

Severity • 52

Shutdown • 40, 42, 118
 Load-Based Rectifier Shutdown • 44
 Over Voltage Shut Down (OVSD) • 40
 Restart Rectifier(s) • 43
 Site Backup Time • 67
Site Backup Time Remaining • 129
 SiteSure-3G I/O module • 79
 Smart Alarm Actions • 59, 64
 Smart Alarm Disconnect • 51
 Smart Alarm Source options • 58
 Smart Alarms • 57
 Smart Analogs • 84
 Smart Analogues Log • 95
 SMS Text Messaging • See GSM Modem Communications
 SNMP • 106
 SNMP trap sending options • 108
 SNMP traps • 107
 SNMP V3 • 106
 SNTP • See Internal Clock
 Software Versions • 4
 Solar Charger Power Share • 38
Solar Comms Lost • 129
 Solar Comms Lost Alarm • 42
Solar Fail • 129
 Sound • See Audible Alarm Indication
 Sources • 58
 Specifications • 123
 Standby Mode • 54, 97, 130
 Start Up Delay • 40
 Starting the SC300 • 7
 String Fail Alarm • 67, 120, 130
 System Alarms • 52, 127
 System Overload Alarm • 54, 56, 130
 System Power • 13, 81, 84
 System States • 86
 System Value Sources • 62

T

Technical Assistance • 159
 Temperature
 Battery Temperature • 13, 35, 65, 84
 Battery Temperature High Alarm • 54, 127
 Battery Temperature Low Alarm • 54, 127
 Heatsink Temperature • 39, 55

Temperature Compensation • 27, 35
 Temperature Sensor • 2, 4, 81, 124, 139
 Test Digital Outputs • 88
 Text Messaging (SMS) • See GSM Modem Communications
 Time • See Internal Clock
 Time Remaining • 65, 66, 70
 Time Synchronization • 19
 Time Zones • 20
 Transient Voltage Protection
 MOV Fail Alarm • 86, 128, 139
 Translation • 24
 trap source • 108
 Troubleshooting • 117
 Repair and Return • 156
 Servicing • 156, 159
 Technical Assistance • 159

U

Unknown Hardware Alarm • 130
 Unmapped IOB Found • 130
Unstable Rectifier AC • 130
 USB
 Connector • 1, 4
 USB Cable • 14
 USB Communications • 14, 120

V

Vertical/Horizontal Setting of Display • See Display Settings
 Voltage (Bus) • 81, See Bus Voltage Sense
 Voltage Control • 27
 Active Voltage Control • 27, 29
 Bus Voltage Sense • 2, 29, 139
 Voltage Feed Module • 4

W

Web
 Browsers (recommended) • 4
 Language • 24
 Web Access Security • 115, 119
 Web Server • 104, 119
 Write Access Password • 114, 119