

User Manual



**Commander RT
PSCRT1100/2000/3000
Line Interactive Sinewave UPS
Uninterruptible Power Supply System**



NetGuard®

UPS Monitoring Software

IMPORTANT

Download the latest NetGuard Monitoring Software:

www.powershield.com.au/index.php/downloads

Default password is: administrator

Introduction

Thank you for choosing PowerShield.

PowerShield Commander RT UPS series are designed to provide the highest level of protection against disturbances found on electrical power supply lines. It is suitable for most applications including IT, security, telephone, broadcasting, medical etc.

The Commander UPS series are designed to provide the most comprehensive protection for your valuable electronic equipment, hardware, software and data from harmful disturbances found on AC power lines including blackouts, power sags, power surges, under voltage, over voltage, line noise, frequency variation, switching transients and harmonic distortions. The Commander RTs will continuously protect your equipment by internally isolating your equipment from the utility power ensuring that all your equipment always receives clean, uninterrupted and stable power.

Very Important !! : WARRANTY REGISTRATION

In order to validate product warranty, it is essential that you register your UPS on line.

Please Visit PowerShield on line product warranty web page

www.powershield.com.au/product-registration.php

This user manual contains instructions relating to safety, installation, operation, maintenance and warranty of this product.

Please keep this manual in a safe place for future references.

Special Symbols

The following are examples of symbols used on the UPS to alert you the important information.

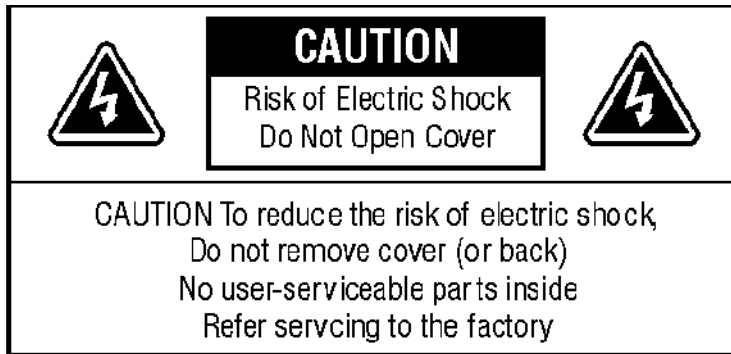

RISK OF ELECTRIC SHOCK -

Indicates that a risk of electric shock is present and the associated warning should be observed



CAUTION; REFER TO OPERATOR'S MANUAL -

Refer to your operator's manual for additional information, such as important operating and maintenance.



SAFETY EARTHING TERMINAL -

Indicates the primary safety ground.

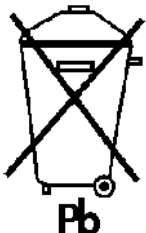

This symbol indicates that you should not discard the UPS or the UPS batteries in the trash. The UPS may contain sealed, lead-acid batteries. Batteries must be recycled.

Table of Contents

1.  Important Safety Warning	4
1-1. Transportation	4
1-2. Preparation	4
1-3. Installation	4
1-4. Operation	5
1-5. Maintenance, service and faults	5
2. Installation And Setup	6
2-1. Rear Panel View	6
2-2. Installation of the UPS	7
2-3. Setup the UPS	7
3. Operations	9
3-1. Button Operation	9
3-2. LCD Panel	10
3-3. Audible Alarm	11
3-4. LCD Display Wordings Index	11
3-5. UPS Setting	11
3-6. Operating Mode Description	15
3-7. Faults Reference Code	16
3-8. Warning Indicator	16
4. Troubleshooting	17
4-1. Battery Replacement	18
4-2. Battery Kit Assembly (option)	19
5. Service	21
6. Storage and Maintenance	22
6-1. Operation	22
6-2. Storage	22
7. Contacting PowerShield	22
8. Specifications	23

1. Important Safety Warning

Please comply with all warnings and operating instructions in this manual. Save this manual properly and read carefully the following instructions before installing the unit. Do not operate this unit before reading through all safety information and operating instructions carefully

1-1. Transportation

- Please transport the UPS system only in the original package to protect against shock and impact.
- **Handling Safety**

 Do not lift heavy loads without assistance.

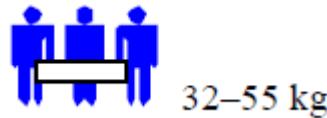
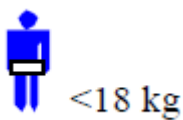

This equipment is intended for installation in a controlled temperature indoor area free from conductive contaminants.

1-2. Preparation

- Condensation may occur if the UPS system is moved directly from cold to warm environment. The UPS system must be absolutely dry before being installed. Please allow at least two hours for the UPS system to acclimate to the environment.
- Do not install the UPS system near water or in moist environments.
- Do not install the UPS system where it would be exposed to direct sunlight or near heater.
- Do not block ventilation holes in the UPS housing.

1-3. Installation

- Do not connect appliances or devices which would overload the UPS system (e.g. laser printers) to the UPS output sockets.
- Place cables in such a way that no one can step on or trip over them.
- Do not connect domestic appliances such as hair dryers to UPS output sockets.
- The UPS can be operated by any individuals with no previous experience.
- Connect the UPS system only to an earthed shockproof outlet which must be easily accessible and close to the UPS system.
- Please use only VDE-tested, CE-marked mains cable (e.g. the mains cable of your computer) to connect the UPS system to the building wiring outlet (shockproof outlet).
- Please use only VDE-tested, CE-marked power cables to connect the loads to the UPS system.
- Pluggable equipment includes a protective earth conductor that carries the leakage current from the load devices (computer equipment). Total leakage current must not exceed 3.5mA.

1-4. Operation

- Do not disconnect the mains cable on the UPS system or the building wiring outlet (shockproof socket outlet) during operations since this would cancel the protective earthing of the UPS system and of all connected loads.
- The UPS system features its own, internal current source (batteries). The UPS output sockets or output terminals block may be electrically live even if the UPS system is not connected to the building wiring outlet.
- In order to fully disconnect the UPS system, first press the OFF/Enter button to disconnect the mains.
- Prevent no fluids or other foreign objects from inside of the UPS system.

1-5. Maintenance, service and faults

- The UPS system operates with hazardous voltages. Repairs may be carried out only by qualified maintenance personnel.
- **Caution** - risk of electric shock. Even after the unit is disconnected from the mains (building wiring outlet), components inside the UPS system are still connected to the battery and electrically live and dangerous.
- Before carrying out any kind of service and/or maintenance, disconnect the batteries and verify that no current is present and no hazardous voltage exists in the terminals of high capability capacitor such as BUS-capacitors.
- Only persons are adequately familiar with batteries and with the required precautionary measures may replace batteries and supervise operations. Unauthorized persons must be kept well away from the batteries.
- **Caution** - risk of electric shock. The battery circuit is not isolated from the input voltage. Hazardous voltages may occur between the battery terminals and the ground. Before touching, please verify that no voltage is present!
- Batteries may cause electric shock and have a high short-circuit current. Please take the precautionary measures specified below and any other measures necessary when working with batteries:
 - remove wristwatches, rings and other metal objects
 - use only tools with insulated grips and handles.
- When changing batteries, install the same number and same type of batteries.
- Do not attempt to dispose of batteries by burning them. This could cause battery explosion.
- Do not open or destroy batteries. Escaping electrolyte can cause injury to the skin and eyes. It is toxic.
- Please replace the fuse only with the same type and amperage in order to avoid fire hazards.
- Do not dismantle the UPS system.

2. Installation And Setup

NOTE: Before installation, please inspect the unit. Be sure that nothing inside the package is damaged. Please keep the original package in a safe place for future use.

2-1. Rear Panel View

PSCRT1100

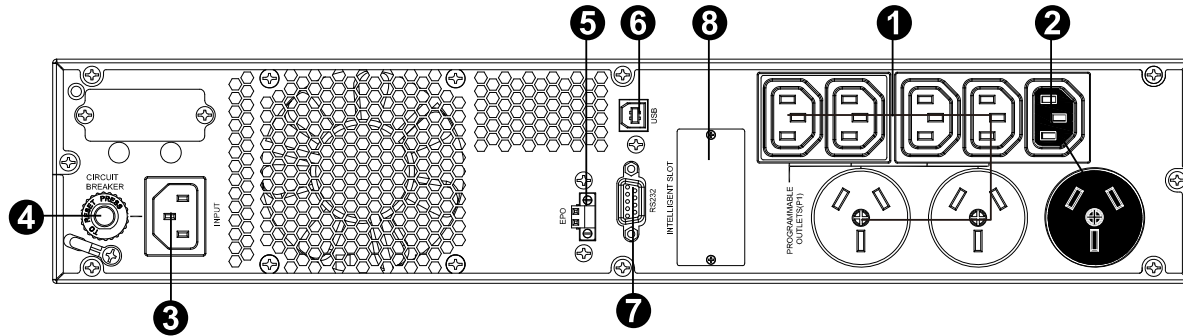

PSCRT2000

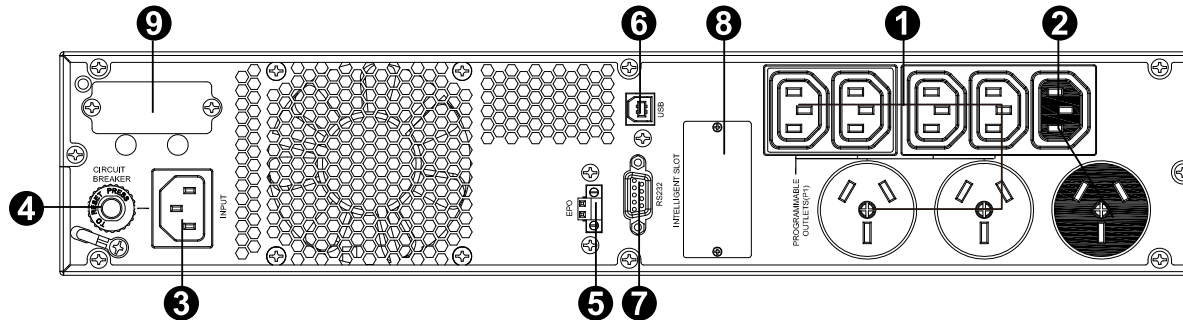

PSCRT3000

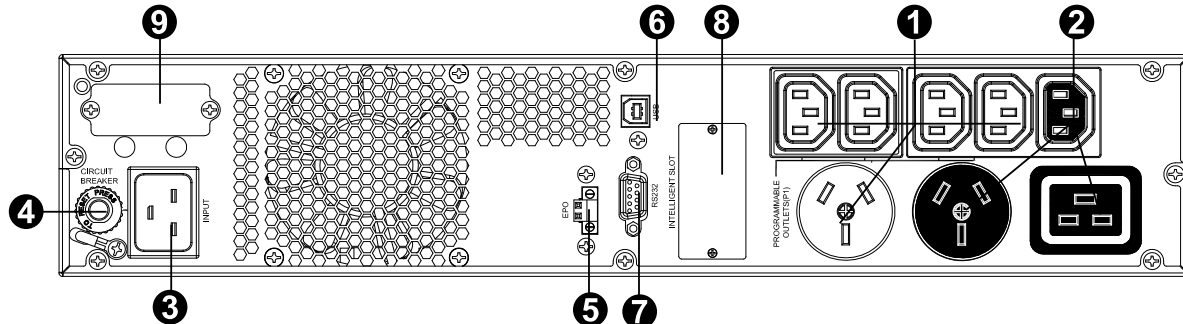

1. Programmable outlets: connect to non-critical loads.
2. Output receptacles: connect to mission-critical loads.
3. AC input
4. Input circuit breaker
5. Emergency power off function connector (EPO)
6. USB communication port
7. RS-232 communication port
8. SNMP intelligent slot
9. External battery connector (only available for 2000/3000 models)

2-2. Installation of the UPS

COMMANDER RT Series can be mounted vertically and horizontally. Please installation below for tower and rack mount installation steps.

● Rack-mount Installation

Step 1

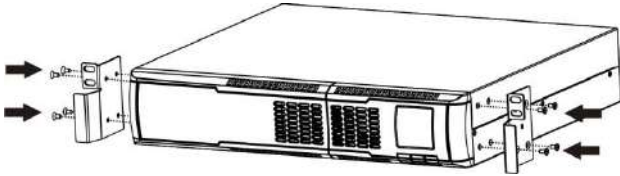

Step 2

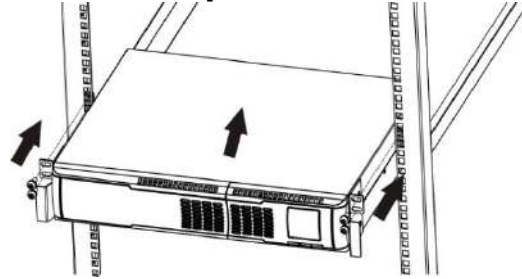

● Tower Installation

Step 1

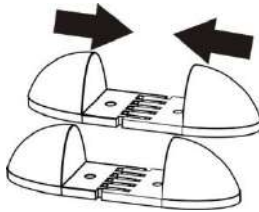

Step 2

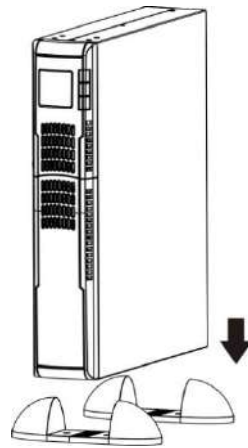

Step 3

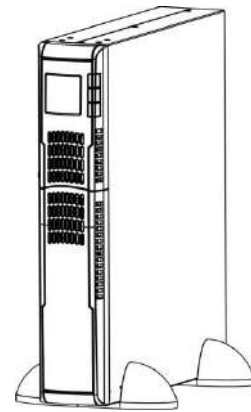

2-3. Setup the UPS

Step 1: UPS input connection

Plug the UPS into a two-pole, three-wire, grounded receptacle only. Avoid using extension cords.

Step 2: UPS output connection

There two kinds of outputs: programmable outlets(**white coloured outlets**)and general outlets (**black coloured outlets**).

Please connect **non-critical devices to the programmable outlets** and **critical devices to the general outlets.**

During power failure, you may extend the backup time to critical devices by setting shorter backup time for non-critical devices.

Step 3: Communication connection

Interface ports:

USB port



RS-232 port

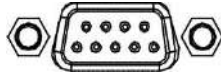

Intelligent slot



To allow for unattended UPS shutdown/start-up and status monitoring, connect the communication cable one end to the USB/RS-232 port and the other to the communication port of your PC. With the monitoring software installed, you can schedule UPS shutdown/start-up and monitor UPS status through PC.

The Commander RT series are equipped with intelligent slot perfect for either SNMP or AS400 card. When installing either SNMP or AS400 card in the UPS, it will provide advanced communication and monitoring options.

Step 4: EPO (Emergency Power OFF) function

Keep the pin 1 and pin 2 closed for UPS normal operation. To activate EPO function, cut the wire between pin 1 and pin 2.

Note: The EPO function logic can be set up via LCD setting. Please refer to program 7 in UPS setting for the details.

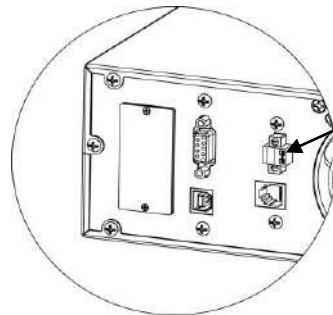

It's in closed status for UPS normal operation as default.

Step 5: External battery connection (for Commander RT 2000 and 3000)

Connect one end of external battery cable to UPS unit and the other end to battery box. And set the correct total battery capacity via LCD setting. Please refer to program 6 in UPS setting for the details.

NOTE: Maximum connected external battery boxes up to 2 units.

Step 6: Turn on the UPS

Press the ON/Mute button on the front panel for two seconds to power on the UPS.

Note: The battery charges fully during the first five hours of normal operation. Do not expect full battery run capability during this initial charge period.

Step 7: Install software

Install NetGuard UPS monitoring software to fully configure UPS shutdown. Please follow steps below to download and install monitoring software:

1. Go to the website <http://www.powershield.com.au/downloads>
2. Click NetGuard software icon and then choose your required OS to download the software.
3. Follow the on-screen instructions to install the software.
4. When your computer restarts, the monitoring software will appear as an orange plug icon located in the system tray, near the clock.

3. Operations

3-1. Button Operation

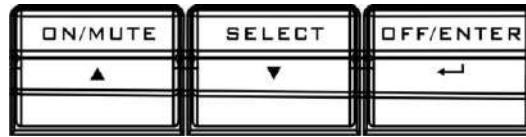

Button	Function
ON/MUTE Button	<ul style="list-style-type: none"> ➤ Turn on the UPS: Press and hold ON/Mute button for at least 2 seconds to turn on the UPS. ➤ Mute the alarm: After the UPS is turned on in battery mode, press and hold this button for at least 3 seconds to disable or enable the alarm system. But it's not applied to the situations when warnings or errors occur. ➤ Up key: Press this button to display previous selection in UPS setting mode. ➤ Switch to UPS self-test mode: Press and hold ON/Mute button for 3 seconds to enter UPS self-testing while in AC mode
OFF/ENTER Button	<ul style="list-style-type: none"> ➤ Turn off the UPS: Press and hold this button at least 2 seconds to turn off the UPS ➤ Confirm selection key: Press this button to confirm selection in UPS setting mode.
SELECT Button	<ul style="list-style-type: none"> ➤ Switch LCD message: Press this button to change the LCD message for input voltage, input frequency, battery voltage, output voltage and output frequency. ➤ Setting mode: Press and hold this button for 3 seconds to enter UPS setting mode when UPS is off. ➤ Down key: Press this button to display next selection in UPS setting mode.
ON/Mute + Select Button	<ul style="list-style-type: none"> ➤ Exit setting mode: If it's already in top menu, press these two buttons at the same time to exit the setting mode. ➤ Return to the upper menu: When working in setting mode, press ON/Mute and Select buttons simultaneously for 0.2 seconds to return to the upper menu.
Select + OFF/Enter Button	<ul style="list-style-type: none"> ➤ Rack or Tower display switch: Press Select and OFF/Enter buttons simultaneously for 3 seconds to switch LCD display direction from/to Rack to/from Tower.

3-2. LCD Panel

Rack Display

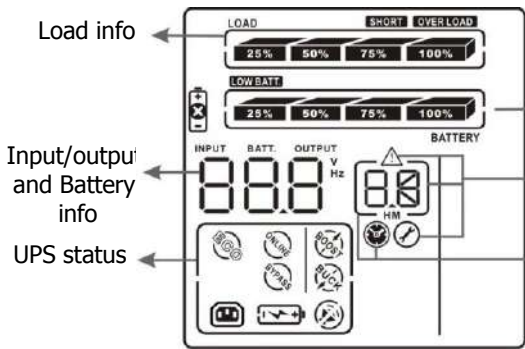

Load info
Input/output and Battery info
UPS status

Battery info
Warning & Fault info/
Setting operation
Backup time info

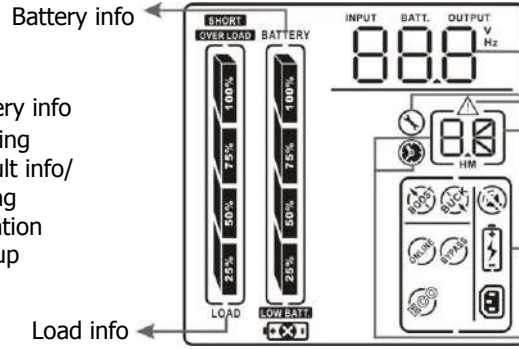

Tower Display



Battery info
Load info

Input/output and Battery info
Warning & Fault info/
Setting operation
UPS status
Backup time info

Display	Function
Backup time information	
	Indicates the backup time in pie chart.
	Indicates the backup time in numbers. H: hours, M: minute
Warning & Fault information	
	Indicates that the warning and fault occurs.
	Indicates the warning and fault codes, and the codes are listed in details in section 3-7 and 3-8.
Setting Operation	
	Indicates the setting operations are listed in details in section 3-5.
Input/Output & Battery information	
	Indicates the output/input voltage, output/input frequency or battery voltage. V: voltage, Hz: frequency
Load information	
	Indicates the load level by 0-25%, 26-50%, 51-75%, and 76-100%.
	Indicates overload.
	Indicates the load or the UPS output is short circuited.
UPS status	
	Indicates that programmable management outlets are working.
	Indicates that the UPS alarm is disabled.
	Indicates the UPS powers the output directly from the mains
	Indicates the UPS is working in battery mode.
	Indicates the battery charger is working.
	Indicates the UPS is working in boost mode
	Indicates the UPS is working in buck mode
Battery information	

	Indicates the Battery level by 0-25%, 26-50%, 51-75%, and 76-100%.
	Indicates low battery.
	Indicates there is something wrong with battery.

3-3. Audible Alarm

Battery Mode	2 beeps every 30 seconds
Low Battery	Rapid one beep every second
Overload	2 short beeps every 2 seconds
Fault	Continuously sounding

3-4. LCD Display Wordings Index

Abbreviation	Display content	Meaning
ENA	ENR	Enable
DIS	di S	Disable
ESC	ESC	Escape
AO / AC	AO / AC	Active Open / Close
ST1/2/3	St 1 / St 2 / St 3	Input Waveform Sensitivity 1/2/3
AUT / AON	AUT / AON	Automatic / Always on
OK	OK	OK
ON	ON	ON
SF	SF	Site Fault
EP	EP	EPO
TP	EP	Temperature
CH	CH	Charger
BR	BR	Battery Replacement
EE	EE	EEPROM error

3-5. UPS Setting

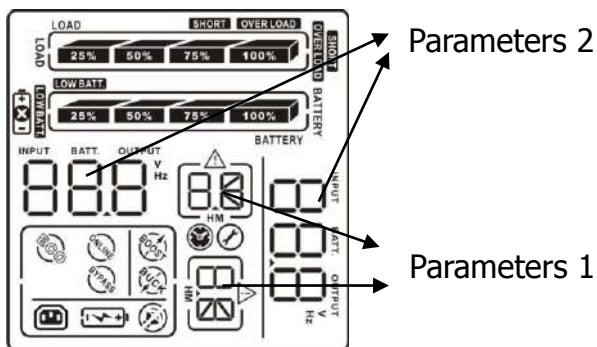

There are two parameters to set up the UPS.
 Parameter 1: It's for program alternatives. There are 9 programs to set up.

- 01: Output voltage setting

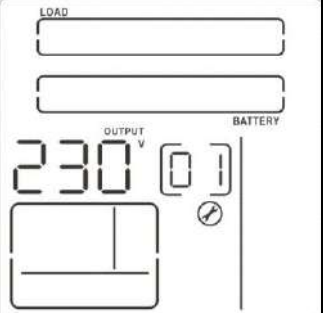
Interface	Setting
 <p>The diagram shows a control panel with two horizontal bars at the top labeled 'LOAD' and 'BATTERY'. Below them is a digital display showing '230' with a 'V' symbol and '01' in a box. To the right of the display is a rotary switch with a '0' and a '1' position. Below the display is a small window with a vertical line and a '0'.</p>	<p>For 200/208/220/230/240 VAC models, you may choose the following output voltage:</p> <p>200: presents output voltage is 200Vac 208: presents output voltage is 208Vac 220: presents output voltage is 220Vac 230: presents output voltage is 230Vac 240: presents output voltage is 240Vac (Default setting)</p>

- 02: Programmable outlets enable/disable

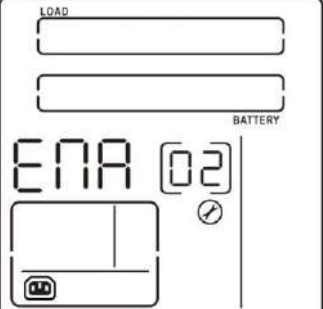
Interface	Setting
 <p>The diagram shows a control panel with two horizontal bars at the top labeled 'LOAD' and 'BATTERY'. Below them is a digital display showing 'ENA' and '02' in a box. To the right of the display is a rotary switch with a '0' and a '2' position. Below the display is a small window with a vertical line and a '0'.</p>	<p>ENA: Programmable outlets enable DIS: Programmable outlets disable (Default setting)</p>

- 03: Programmable outlets setting

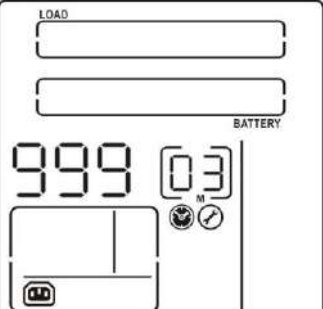
Interface	Setting
 <p>The diagram shows a control panel with two horizontal bars at the top labeled 'LOAD' and 'BATTERY'. Below them is a digital display showing '999' and '03' in a box. To the right of the display is a rotary switch with a '0' and a '3' position. Below the display is a small window with a vertical line and a '0'.</p>	<p>Setting the backup time limits in minutes from 0-999 for programmable outlets which connect to non-critical devices on battery mode.</p>

- 04: Site fault detection enable/disable

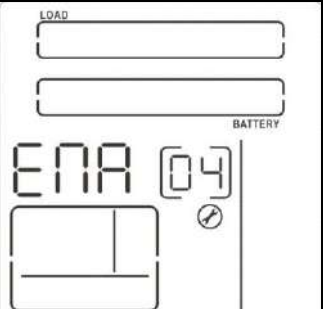
Interface	Setting
 <p>The diagram shows a control panel with two horizontal bars at the top labeled 'LOAD' and 'BATTERY'. Below them is a digital display showing 'ENA' and '04' in a box. To the right of the display is a rotary switch with a '0' and a '4' position. Below the display is a small window with a vertical line and a '0'.</p>	<p>ENA: Site fault detection enable (Default setting) DIS: Site fault detection disable</p>

● 05: Autonomy limitation setting

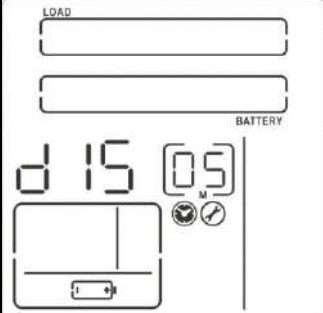
Interface	Setting
	<p>0-999: setting the backup time in minutes from 0-999 for general outlets on battery mode. DIS: Disable the autonomy limitation and the backup time will depend on battery capacity. (Default) Note: When setting as "0", the backup time will be only 10 seconds.</p>

● 06: Total battery AH setting

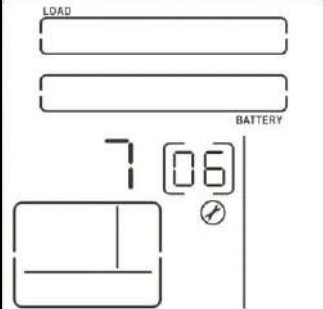
Interface	Setting
	<p>7-81: setting the total battery capacity from 7-81 in AH. Please set the correct battery total capacity if external battery bank is connected.</p>

● 07: EPO logic setting

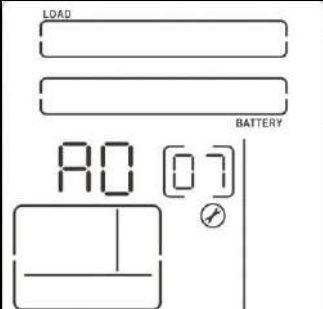
Interface	Setting
	<p>AO: Active Open (Default). When AO is selected as EPO logic, it will activate EPO function with Pin 1 and Pin 2 in open status. AC: Active Close. When AC is selected as EPO logic, it will activate EPO function with Pin 1 and Pin 2 in close status.</p>

● 08: Input Waveform Sensitivity

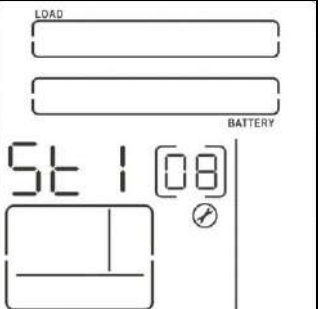
Interface	Setting
	<p>St1: Input voltage waveform detection is highly sensitive. St2: Input voltage waveform detection is middle sensitive. (Default) St3: Input voltage waveform detection is low sensitive.</p>

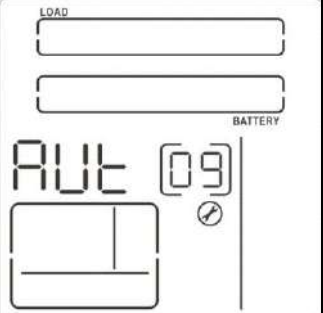

● 09: LCD display backlight setting

Interface	Setting
	<p>Aon: LCD display backlight is on all the time Aut: LCD display backlight will be off after pressing the buttons 60seconds. (Default setting)</p>

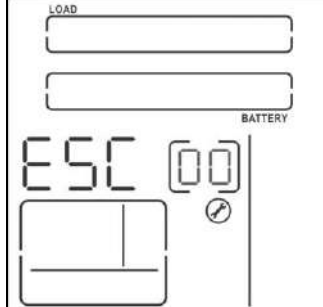
● 00: Exit setting

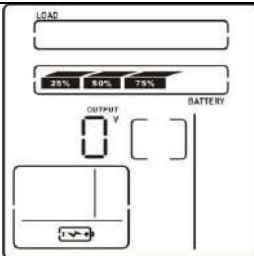

Interface	Setting
	<p>Exit the setting mode.</p>

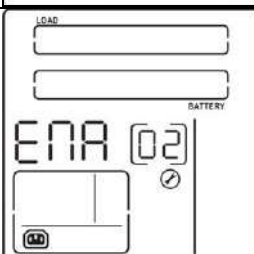
Steps for setting programmable outlet (White Coloured Outlets)

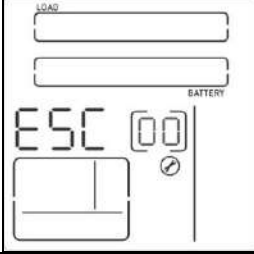
<p>Step 1: Before entering setting mode, the UPS should be in Stand-by mode (off-charging) and make sure the battery is connected. The LCD display is shown as right.</p>	
<p>Step 2: Press and hold the "Selection" button for 5 seconds to enter Setting mode.</p>	
<p>Step 3: Press the "Up" button (ON/MUTE) to switch to "02" of program list. Then press "Enter" button to enter value setting of parameter 2. Press the "Up" button to change the value to "ENA" to enable the programmable outlet function. Then press "Enter" button again to confirm the setting.</p>	

<p>Step 4: Press the "Up" button (ON/MUTE) again to switch to "03" of program list. Then press "Enter" button for setting programmable outlet time. Push "Up" button to change the value of backup time according your demand. Then press "Enter" to confirm the setting.</p>	
<p>Step 5: Press "Up" button (ON/MUTE) to switch to "00" of program list. Then press "Enter" button to exit setting menu.</p>	
<p>Step 6: Disconnect AC input and wait until the LCD display is off. The new setting will be activated when turning on the UPS again.</p>	

3-6. Operating Mode Description

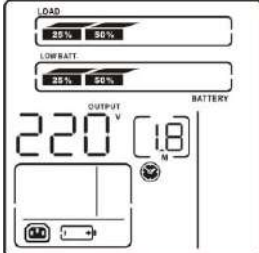

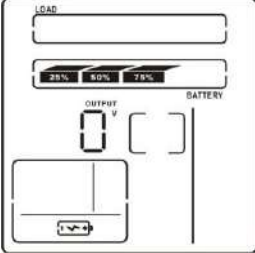
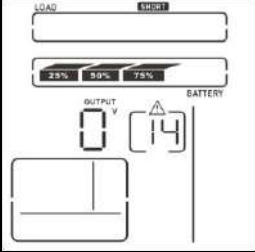







Operating mode	Description	LCD display
ECO mode	When the input voltage is within voltage regulated range, UPS will power the output directly from the mains. ECO is an abbreviation of <u>Efficiency Corrective Optimizer mode</u> . In this mode, when battery is fully charged, the fan will stop working for energy saving.	
Buck mode when AC is normal.	When the input voltage is higher than the voltage regulation range but lower than high loss point, the buck AVR will be activated.	
Boost mode when AC is normal.	When the input voltage is lower than the voltage regulation range but higher than low loss point, the boost AVR will be activated.	
Battery mode	When the input voltage is beyond the acceptable range or power failure and alarm is sounding 2 beeps every 30 seconds, UPS will backup power from battery.	

Standby mode	UPS is powered off and no output supply power, but still can charge batteries.	
Fault mode	When a fault occurs, the ERROR icon and the fault code will be displayed.	

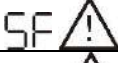
3-7. Faults Reference Code

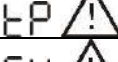





Fault event	Fault code	Icon	Fault event	Fault code	Icon
Bus start fail	01	x	Inverter output short	14	SHORT
Bus over	02	x	Battery voltage too high	27	x
Bus under	03	x	Battery voltage too low	28	
Inverter soft start fail	11	x	Over temperature	41	x
Inverter voltage high	12	x	Over load	43	OVER LOAD
Inverter voltage Low	13	x	Charger failure	45	x

3-8. Warning Indicator

Warning	Icon (flashing)	Alarm
Low Battery		Rapid one beep every second
Overload		2 short beeps every 2 seconds
Battery is not connected		2 short beeps every 2 seconds
Overcharge		Continuously sounding
Site wiring fault		2 short beeps every 2 seconds
EPO enable		2 short beeps every 2 seconds
Over temperature		Continuously sounding
Charger failure		Continuously sounding
Battery Fault		Continuously sounding
Battery replacement		2 short beeps every 2 seconds
EEPROM error		2 short beeps every 2 seconds

4. Troubleshooting

If Commander RT series do not operate correctly, please solve the problem by using the table below.

Symptom	Possible cause	Remedy
No indication and alarm even though the mains is normal.	The AC input power is not connected well.	Check if input power cord firmly connected to the mains.
	The AC input is connected to the UPS output.	Plug AC input power cord to AC input correctly.
The icon  and the warning code EP flashing on LCD display and alarm is sounding 2 short beeps every 2 seconds	EPO function is activated.	Set the circuit in close position to disable EPO function.
The icon  and SF flashing on LCD display and alarm is sounding 2 short beeps every 2 seconds	Line and neutral conductors of UPS input are reversed.	Rotate mains power socket by 180° and then connect to UPS system.
The icon  and  flashing on LCD display and alarm is sounding 2 short beeps every 2 seconds	The external or internal battery is incorrectly connected.	Check if all batteries are connected well.
Fault code is shown as 27 and the icon  is lighting on LCD display and alarm is continuously sounding.	Battery voltage is too high or the charger is fault.	Contact your dealer.
Fault code is shown as 28 and the icon  is lighting on LCD display and alarm is continuously sounding.	Battery voltage is too low or the charger is fault.	Contact your dealer.
The icon  and the icon OVER LOAD are flashing on LCD display and alarm is sounding 2 short beeps every 2 seconds.	UPS is overload	Remove excess loads from UPS output.
Fault code is shown as 43 and The icon OVER LOAD is lighting on LCD display and alarm is continuously sounding.	The UPS shut down automatically because of overload at the UPS output.	Remove excess loads from UPS output and restart it.
Fault code is shown as 14 and alarm is continuously sounding.	The UPS shut down automatically because short circuit occurs on the UPS output.	Check output wiring and if connected devices are in short circuit status.

Symptom	Possible cause	Remedy
Fault code is shown as 01, 02, 03, 11, 12, 13 and 41 on LCD display and alarm is continuously sounding.	A UPS internal fault has occurred.	Contact your dealer
Battery backup time is shorter than nominal value	Batteries are not fully charged	Charge the batteries for at least 5 hours and then check capacity. If the problem still persists, consult your dealer.
	Batteries defect	Contact your dealer to replace the battery.
Fault code is shown as 45 on LCD display. At the same time, alarm is continuously sounding.	The charger does not have output and battery voltage is less than 10V/PC.	Contact your dealer.

4-1. Battery Replacement

NOTICE: The Commander RT series are equipped with internal batteries and user can replace the batteries without shutting down the UPS or connected loads.(hot-swappable battery design)
Replacement battery pack is a safe procedure and isolated from electrical hazards.

CAUTION!! Consider all warnings, cautions, and notes before replacing batteries.

Note: Upon battery disconnection, equipment is not protected from power outages.

Step 1

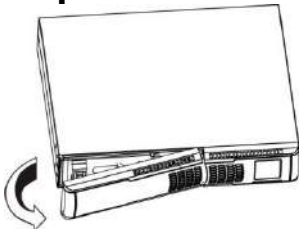

Remove front panel.

Step 2

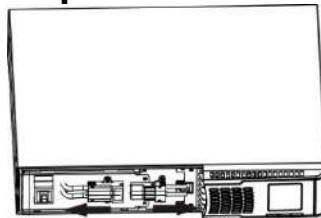

Disconnect battery wires.

Step 3

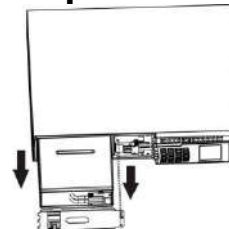

Pull out the battery box by removing two screws on the front panel.

Step 4

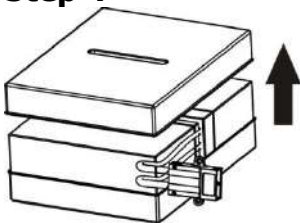

Remove the top cover of battery box and replace the inside batteries.

Step 5

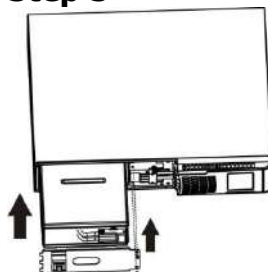

After replacing the batteries, put the battery box back to original location and screw it tightly.

Step 7

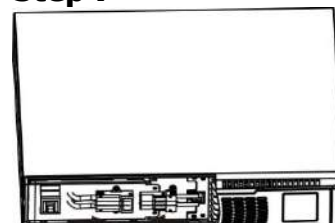

Re-connect the battery wires.

Step 8

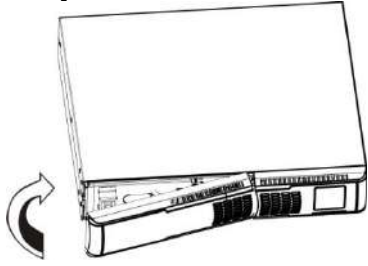

Put the front panel back to the unit.

4-2. Battery Kit Assembly (option)

NOTE : We RECOMMEND TO USE POWERSHIELD CERTIFIED BATTERIES FOR YOUR OWN BATTERY PACK ASSEMBLY.

NOTICE: Please assemble battery kit first before installing it inside of UPS. Please select correct battery kit procedure below to assemble it.

Battery kit for PSCRT800/PSCRT1100

Step 1: Remove adhesive tapes.

Tapes

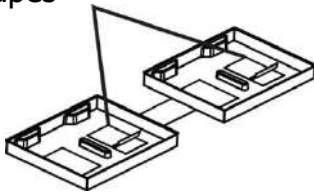

Step 2: Connect all battery terminals by following below chart.

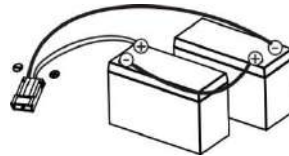

Step 3: Put assembled battery packs on one side of plastic shells and insert one more defect battery on the space.

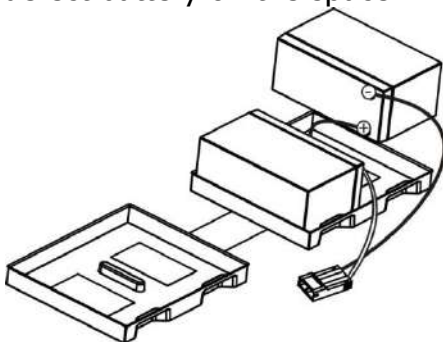

Step 4: Cover the other side of plastic shell as below chart. Then, battery kit is assembly well.

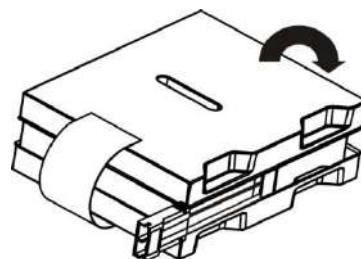

Battery kit for PSCRT2000/PSCRTBB8

Step 1: Remove adhesive tapes.

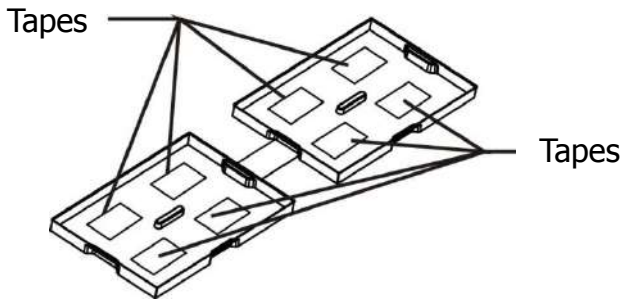

Step 2: Connect all battery terminals by following below chart.

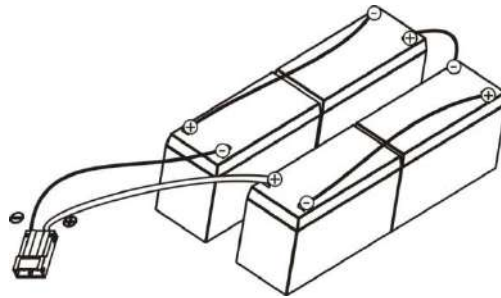

Step 3: Put assembled battery packs on one side of plastic shells.

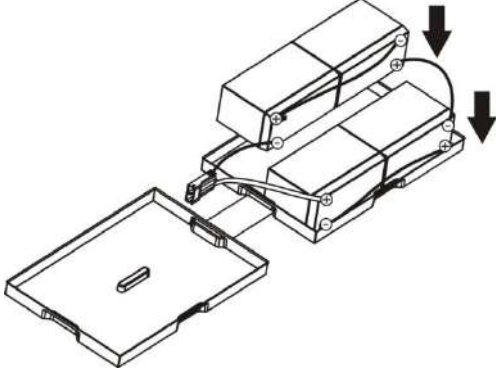

Step 4: Cover the other side of plastic shell as below chart. Then, battery kit is assembly well.

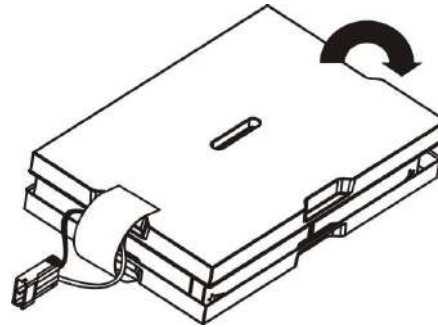

Battery kit for PSCRT3000/PSCRTBB12

Step 1: Remove adhesive tapes.

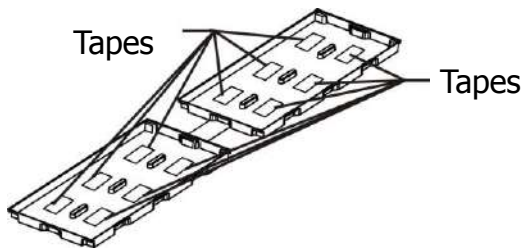

Step 2: Connect all battery terminals by following below chart.

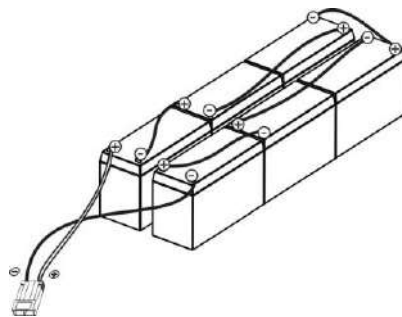

Step 3: Put assembled battery packs on one side of plastic shells.

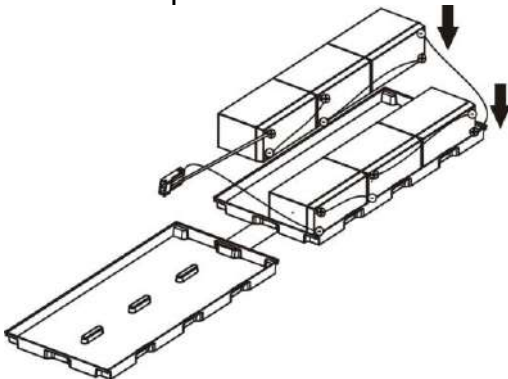

Step 4: Cover the other side of plastic shell as below chart. Then, battery kit is assembly well.

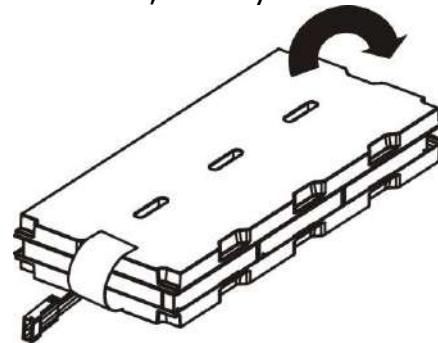

5. Service

WARRANTY CONDITION:

The standard warranty is TWO (2) years from the date of purchase. The standard PowerShield procedure is to replace the original unit with a factory refurbished unit. PowerShield will ship the replacement unit once the defective unit has been received by the service department, or cross ship upon the receipt of a valid credit card number. The customer pays for shipping the defective unit to PowerShield. PowerShield pays ground freight transportation costs to ship the replacement to the customer within Australian capital cities metro areas only.

NOTE : For more information about our Warranty Policy, please visit our web site.

www.powershield.com.au

WARRANTY SERVICE PROCESS :

1. Review the problems discussed in the troubleshoot section of this manual to eliminate common problems.
2. Verify that no input/output circuit breaker are tripped. A tripped circuit breaker is the most common problem.
3. If the problem still persists, please call 1300-305-393 for technical support or fill in the form in PowerShield web page for on line technical support.
Following details are needed for warranty claims.
 - Model number
 - Serial number
 - The date of purchase
4. Be prepare to troubleshoot the problem over the phone with PowerShield technical support.
5. If technical support found that the product is defective, then the technical support will issue a Return Material Authorization Number (RMA #)
6. If the unit is under warranty, repair is free. If not there is a repair charge.
7. Pack the unit in its original packaging. Pack properly to avoid damage during transit. Damage sustained in transit is not covered under warranty.
8. Mark the RMA # on the outside of the package.
9. Return the defective unit by insured, prepaid carrier to the address given to you by Technical support.

6. Storage and Maintenance

6-1. Operation

Commander RT series contains no user-serviceable parts. If the battery service life (3~5 years at 25°C ambient temperature) has been exceeded, the batteries must be replaced.

Please contact your dealer or visit PowerShield web site.

www.powershield.com.au/support.php



Be sure to deliver the spent battery to a recycling facility or ship it to your dealer in the replacement battery packing material.

6-2. Storage

Before storing, charge the UPS 5 hours. Store the UPS covered and upright in a cool, dry location. During storage, recharge the battery in accordance with the following table:

Storage Temperature	Recharge Frequency	Charging Duration
-25°C - 40°C	Every 3 months	1-2 hours
40°C - 45°C	Every 2 months	1-2 hours

7. Contacting PowerShield

Refer to the information provided at PowerShield internet site:

www.powershield.com.au

Or

Phone 1300 305 393

8. Specifications

COMMANDER RT				BATTERY BANKS		
Model	PSCRT1100	PSCRT2000	PSCRT3000	PSRTBB8	PSRTBB12	
Capacity	1100 VA / 990 W	2000 VA / 1800 W	3000 VA / 2700 W	Suits PSCRT2000	Suits PSCRT3000	
Topology	Line Interactive, Pure Sine Wave					
INPUT						
Voltage	240Vac (Nominal)					
Acceptable Voltage Range	162-290 VAC					
Frequency Range	50/60Hz ±5Hz (auto sensing)					
OUTPUT						
Voltage Regulation (AC Mode)	240Vac (Selectable 200/208/220/230Vac) ± 10% AVR					
Voltage Regulation (Batt. Mode)	±1.5%(before battery alarm)					
Frequency Range (Batt. Mode)	50 Hz or 60 Hz ± 1 Hz					
Current Crest Ratio	3:1					
Total Harmonic Distortion	2% max @ 100% linear load, 5% max @ 100% non-linear load (before low battery alarm)					
Transfer Time	6 ms (Typical), 10ms max.					
Waveform (Batt. Mode)	Pure Sine Wave					
EFFICIENCY						
AC Mode	97%					
Buck & Boost Mode	95%					
Battery Mode	88%	90%	91%			
BATTERY						
Standard Model	Battery Type & Number	12 V*9 AH(x 2)	12 V*9 AH(x 4)	12 V*9 AH(x 6)	12 V*9 AH(x 8)	12 V*9 AH(x 12)
	Charging Voltage	27.4 VDC ± 1%	54.8 VDC ± 1%	82.1 VDC ± 1%		
	Recharge Time	4 hours recover to 90% capacity				
Additional Battery Banks	NA	PSRTBB8(x 1)	PSRTBB12(x 1)			
PROTECTION						
Full Protection	Overload, thermal, short circuit, discharge and overcharge protection					
Surge Protection	2064 Joules / 39000 Amps					
COMMUNICATION & MANAGEMENT						
Interface	USB and RS-232 as standard, Intelligent slot for PSSNMP, PSModbus or PSAS400 dry contact					
Software	PowerShield NetGuard® software – supports Windows based operating system, Linux, Unix and Mac					
LCD Display/Alarm	AC mode, Battery Mode, Load Level, Input Voltage, Output Voltage, Overload, Fault, Battery Replacement, Low Battery and Remaining Battery Time					
Audible Alarm	Battery Mode, Low Battery in Battery Mode, Battery Replacement, Fault and Overload					
PHYSICAL						
Dimension (D x W x H)	(380 x 438 x 88) mm	(480 x 438 x 88) mm	(600 x 438 x 88) mm	(480 x 438 x 88) mm	(600 x 438 x 88) mm	
Weight (Net / Gross)	(14.1Kg / 16.5Kg)	(21.3Kg / 24 Kg)	(32.1Kg / 34.5 Kg)	(29Kg / 31.1 Kg)	(41.2Kg / 44.7 Kg)	
OPERATING ENVIRONMENT						
Temperature	0- 40°C					
Operating Humidity	0-90 % (RH Non-condensing)					
Noise Level	< 45dB	< 45dB@Line mode, < 55dB@Battery mode				
COMPLIANCE						
Safety	EN62040-1-1 2003, IEC60950-1-1					
EMC	EN62040-2 2006					
RoHS	Directive 2011/65/EU					

* Derate capacity to 85% of capacity when the output voltage is adjusted to 200/208VAC.

**Product specifications are subject to change without further notice.