



## USER MANUAL

### Centurion RT Li-Iron Phosphate Online Uninterruptible Power Supply

PSLCERT1000 | PSLCERT2000 | PSLCERT3000



### NetGuard<sup>®</sup> Software

Download the latest PowerShield NetGuard<sup>®</sup> UPS Monitoring Software:

[www.powershield.com.au/downloads](http://www.powershield.com.au/downloads)

**Default password:** administrator

ecoLiFePO<sub>4</sub>



DESIGNED BY  
AUSTRALIANS  
FOR AUSTRALIAN  
CONDITIONS



# Introduction

Thank you for choosing PowerShield.

PowerShield Centurion UPS series are designed to provide the highest level of protection against disturbances found on electrical power supply lines. It is suitable for most applications including IT, security, telephone, broadcasting, medical etc.

The Centurion UPS series are designed to provide the most comprehensive protection for your valuable electronic equipment, hardware, software and data from harmful disturbances found on AC power lines including blackouts, power sags, power surges, under voltage, over voltage, line noise, frequency variation, switching transients and harmonic distortions. The Centurion RT's Lithium Iron Phosphate (LiFePO<sub>4</sub> or more simply LiFe) true online double conversion topology will continuously protect your equipment by internally isolating your equipment from the utility power ensuring that all your equipment always receives clean, uninterrupted and stable power.

## **Very Important !! : WARRANTY REGISTRATION**

In order to validate product warranty, it is essential that you register your UPS on line.

Please Visit PowerShield on line product warranty web page at



<https://powershield.com.au/support-menu/warranty-registration/>



This user manual contains instructions relating to safety, installation, operation, maintenance and warranty of this product.

Please keep this manual in a safe place for future reference.

**Special Symbols**

The following symbols are used on the UPS to alert you to important information.

	<b>CAUTION</b> Risk of Electric Shock Do Not Open Cover	
CAUTION To reduce the risk of electric shock, Do not remove cover (or back) No user-serviceable parts inside Refer servicing to the factory		

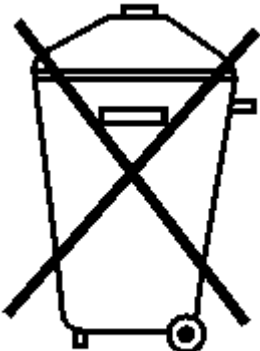
	<b>RISK OF ELECTRIC SHOCK -</b> Indicates that a risk of electric shock is present and the associated warning should be observed
	<b>CAUTION; REFER TO OPERATOR'S MANUAL -</b> Refer to your operator's manual for additional information, such as important operating and maintenance procedures.
	<b>SAFETY EARTHING TERMINAL -</b> Indicates the primary safety ground.
 <b>LiFePO4</b>	This symbol indicates that you should not discard the UPS or the UPS batteries in the trash. The UPS may contain Lithium Iron Phosphate (LiFePO4 or more simply LiFe) batteries. Batteries must be recycled.

# Table of Contents

1. Important Safety Warning.....	4
1-1. Transportation .....	4
1-2. Preparation .....	4
1-3. Installation .....	4
1-4. Operation .....	5
1-5. Maintenance, service and faults.....	5
2. Installation and setup.....	7
2-1 Rear panel view.....	7
2-2. Operating principle .....	8
2-3. Installing the UPS .....	8
2-4. Setting up the UPS.....	9
3. Operations.....	12
3-1. Button operation.....	12
3-2. LCD Panel .....	13
3-3. Audible Alarm.....	14
3-4. LCD display wordings index .....	14
3-5. UPS Parameter Settings .....	15
3-6. Operating Mode Description .....	18
3-7. Faults Reference Code.....	19
3-8. Warning indicator .....	20
4. Troubleshooting .....	21
5. Storage and Maintenance .....	22
5-1. Operation .....	22
5-2. Storage .....	22
6. Specifications.....	23

## 1. Important Safety Warning

For safety reasons, it is essential to comply with all warnings and operating instructions listed in this manual. Do not operate the UPS unit before carefully reading through all safety information and operating instructions. It is recommended that you save and or backup this manual for future reference.

### 1-1. Transportation

- Transport the UPS system using only the original packaging to protect against shock and impact.
- **Handling Safety**



Do not lift heavy loads without assistance.



<18 kg



18–32 kg



32–55 kg



>55 kg

This equipment is intended for installation in a controlled temperature indoor area free from conductive contaminants.

### 1-2. Preparation

- The UPS system must be absolutely dry before installation. As condensation may occur if the UPS system is moved directly from cold to warm environments, allow at least two hours for the UPS system to acclimate to the environment.
- Do not install the UPS system near water or in moist environments.
- Do not install the UPS system where it would be exposed to direct sunlight or near heaters.
- Do not block ventilation holes in the UPS housing.

### 1-3. Installation

- Do not connect appliances or devices which would overload the UPS system (e.g. laser printers) to the UPS output sockets.
- To ensure against physical hazards, place cables safely such that persons cannot accidentally trip over or step on them.
- Do not connect domestic appliances such as hair dryers to UPS output sockets.
- The UPS can be operated by any individuals with no previous experience.
- Connect the UPS system only to an earthed shockproof outlet which must be easily accessible and close to the UPS system.
- Use only VDE-tested, CE-marked mains cable (e.g. the mains cable of your computer) to connect the UPS system to the building wiring outlet (shockproof outlet).
- Please use only VDE-tested, CE-marked power cables to connect the loads to the UPS system.
- When installing the equipment, ensure that the sum of the leakage current of the UPS and the connected devices does not exceed 3.5mA.

## 1-4. Operation

- Do not disconnect the mains cable on the UPS system or the building wiring outlet (shockproof socket outlet) during operations as this will cancel and invalidate the protective earthing of the UPS system and of all connected loads.
- As the UPS system features its own, internal current source (high capacity batteries), the UPS output sockets may be electrically live even if the UPS system is not connected to the building wiring outlet.
- In order to fully disconnect the UPS system, first press the OFF/Enter button to disconnect the mains.
- Prevent fluids or other foreign objects from entering inside of the UPS system.

## 1-5. Maintenance, service and faults

- The UPS system operates with hazardous voltages. Repairs may be carried out only by qualified maintenance personnel.
- **Caution** - risk of electric shock. Even after the unit is disconnected from the mains (building wiring outlet), components inside the UPS system are still connected to the battery and electrically live and dangerous.
- Before carrying out any kind of service and/or maintenance; switch off mains power, then disconnect the batteries and verify that no hazardous voltages are present at the terminals of the large storage capacitors (BUS-capacitors).
- Only persons who are adequately familiar with high capacity batteries, and with the understanding of the required precautionary measures outlined below are permitted to replace batteries and supervise operations. Unauthorized persons must be kept well away from the batteries.
- **Caution** - risk of electric shock. The battery circuit is not isolated from the input voltage. Hazardous voltages may occur between the battery terminals and the ground. Before touching, please verify that no voltage is present!
- Batteries may cause electric shock and have very high short-circuit current. When working with batteries always ensure the following precautionary measures are adhered to:
  - a) Remove all jewelry items (watches, rings, and metal objects).
  - b) Use only tools with insulated grips and handles.
  - c) Do not lay tools or metal parts on top of the batteries.
  - d) Disconnect the charging source and load prior to installing or performing service and maintenance on the battery.
  - e) Remove battery grounds during installation and maintenance to reduce likelihood of shock. Remove the connection from ground if any part of the battery is determined to be grounded.

- When changing batteries, always install the same number and same type of batteries or battery packs.

Manufacturer	Type	Rated
PowerShield	LIFE-247500	25.6 V dc, 7.5 Ah
	LIFE-485000	48 V dc, 5.0 Ah
	LIFE-722500	76.8 V dc, 2.5 Ah

- For UPS with internally mounted battery
  - a) Instructions shall carry sufficient information to enable the replacement of the battery with a suitable manufacturer and catalogue number.
  - b) Safety instructions to allow access by Service Personnel shall be stated in the installation/service handbook.
  - c) If batteries are to be installed by Service Personnel, instructions for interconnections, including terminal torque, shall be provided.
- Do not attempt to dispose of batteries by burning as they may explode.
- Do not open or destroy batteries. Escaping electrolyte can cause injury to the skin and eyes. It may be toxic.
- Replacement fuses must be of the same type and amperage (current rating) in order to avoid fire hazards.
- Do not dismantle the UPS system.
- **WARNING:** This is a category C2 UPS product. In a residential environment, this product may cause radio interference, in which case the user may be required to take additional measures.

## 2. Installation and setup

**NOTE:** Inspect the unit before installation for any evidence of mistreatment or damage of contents inside the packaging during transport. Store the original package in a safe place for future use.

**NOTE:** The PowerShield Lithium Iron Phosphate (LiFePO<sub>4</sub>) online UPS models support internal LiFePO<sub>4</sub> batteries. Please refer to the following model table.

Model No.	Type
PSLCERT1000	Standard LiFePO <sub>4</sub> Model with internal LiFePO <sub>4</sub> batteries
PSLCERT2000	
PSLCERT3000	

### 2-1 Rear panel view

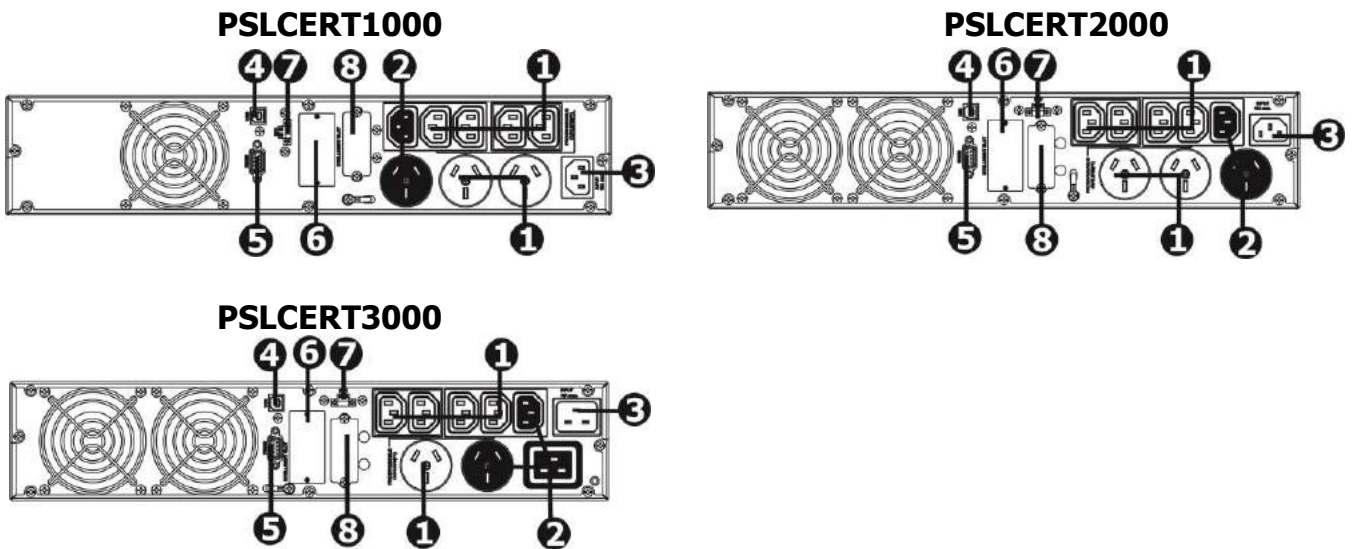

1. Programmable outlets: connect to non-critical loads.
2. Output receptacles: connect to mission-critical loads.
3. AC input
4. USB communication port
5. RS-232 communication port
6. SNMP intelligent slot
7. Emergency power off function connector (EPO)
8. External battery connector



## 2-2. Operating principle

The operating principle of the UPS is shown as below

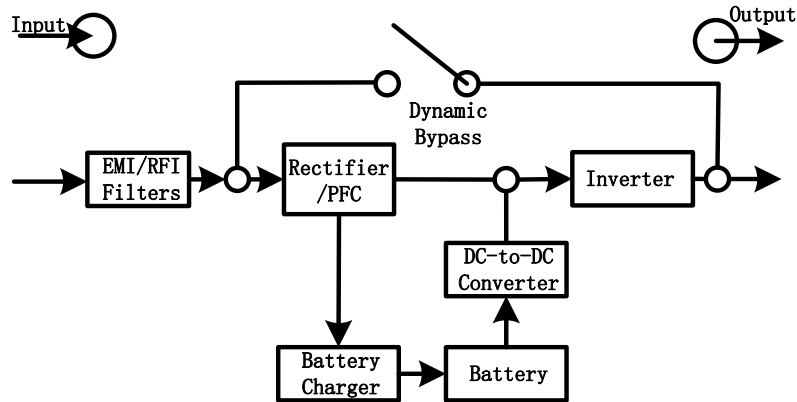

The UPS is composed of mains input, EMI/RFI filters, rectifier/PFC, inverter, battery charger, DC-to-DC converter, battery, dynamic bypass and UPS output.

## 2-3. Installing the UPS

The UPS is usually shipped from the factory with the battery wires connected. Note: LCD and alarm will indicate if battery wires are not connected at the start of the power up sequence. If not connected, please follow the steps below to re-connect the battery wires.

### Step 1

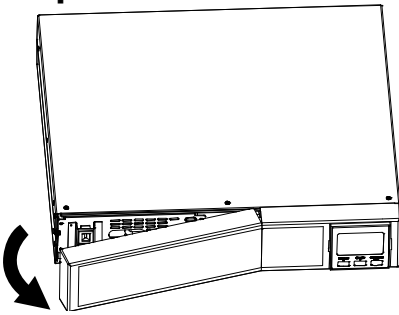

Remove front panel.

### Step 2

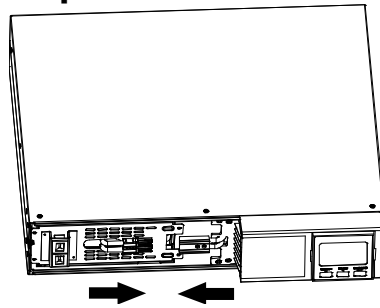

Re-connect DC battery wires and connect the AC input.

### Step 3

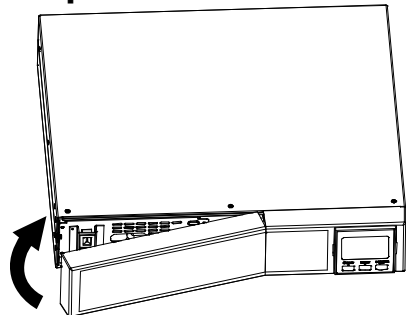

Put the front panel back to the unit.

This UPS can be used as either a stand-alone tower or rack mounted in a 19" chassis. Please choose from the appropriate installation instructions below to position the UPS accordingly.

## Rack-mount Installation

### Step 1

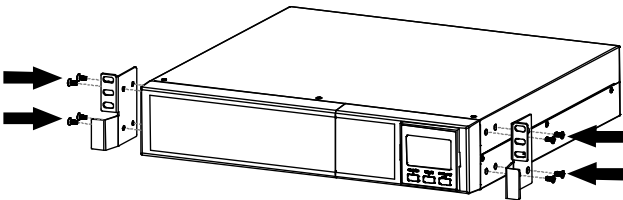

### Step 2

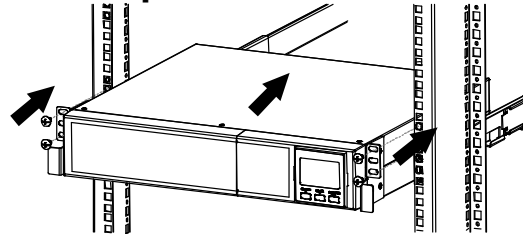

## Tower Installation

### Step 1

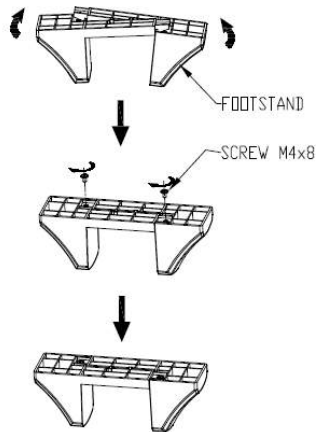

### Step 2

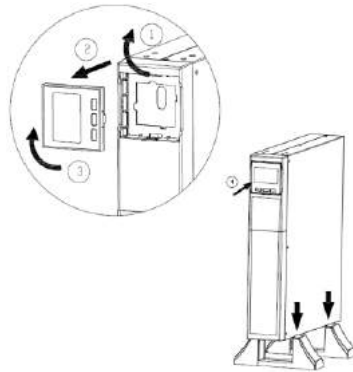

### Step 3

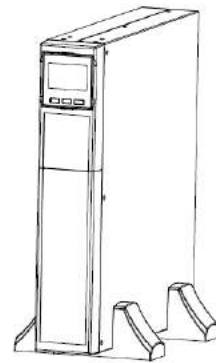

Contact [www.powershield.com.au](http://www.powershield.com.au) on 1300-305-393 for optional PowerShield Rail Kit - PSRK

## 2-4. Setting up the UPS

Please take note of the points below to select an appropriate location for the UPS installation.

1. Install the UPS indoors, in a clean environment, where it is away from window and doors. The UPS should be placed on a flat and clean surface, in an area away from vibration, dust, humidity, high temperature, flammable liquids, gases, corrosive and conductive contaminants. Maintain minimum clearance of 100mm around the bottom of the UPS to avoid dust and high temperature.
2. Maintain an ambient temperature range of 0°C to 45°C for UPS optimal operation. For every 5°C above 45°C, the UPS will de-rate 12% of nominal capacity at full load. The highest permissible working temperature for UPS operation is 50°C.
3. There is a service ceiling limit, with a maximum altitude of 1000m, for the UPS to operate at full load. If the UPS is to be used at higher altitudes, please consult the connected load altitude derating power chart below for normal UPS operation:

Altitude m	Derating factor <sup>1)</sup>
1000	1.0
1500	0.95
2000	0.91
2500	0.86
3000	0.82
3500	0.78
4000	0.74
4500	0.7
5000	0.67
NOTE – Note to table 1	
Based on density of dry air = 1.225 kg/m <sup>3</sup> at sea-level, +15°C.	
<sup>1)</sup> Since fans lose efficiency with altitude, the forced air-cooled equipment may require further derating.	

#### 4. UPS placement location :

As the UPS is equipped with fan forced cooling, please place the UPS in a well-ventilated area. Maintain minimum clearance of 100mm at the front of the UPS and 300mm at the rear and around both sides of the UPS for efficient heat dissipation and easy-maintenance.

#### Step 1: UPS input connection

When connecting the UPS to the mains supply always use a three-pin plug, three-wire, grounded receptacle and avoid using extension cords.

#### Step 2: UPS output connection

There are two kinds of socket-type outputs: programmable outlets (white coloured outlets) and general outlets (black coloured outlets). Connect non-critical devices to the programmable outlets and critical devices to the general outlets. The backup time to critical devices may be extended during power failure by setting shorter backup time for non-critical devices.

#### Step 3: Communication connection

##### Communication port:

##### USB port



##### RS-232 port

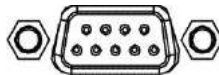

##### Intelligent slot



To allow for unattended UPS shutdown/start-up and status monitoring, connect the communication cable on one end to the USB or RS-232 port of the UPS and the other to the USB or RS232 communication port of your PC. With the monitoring software installed, you can schedule UPS shutdown/start-up and monitor UPS status through the PC.

The UPS is equipped with an intelligent slot to accommodate either an SNMP or AS400 card. When installed, either the SNMP or AS400 card will provide advanced communication and monitoring options for the UPS.

*Please Note: The USB port and RS-232 port can NOT operate at the same time.*

#### Step 4: Disable and enable EPO function

This UPS is equipped with EPO function. By default, the UPS is delivered from factory with Pin 1 and pin 2 closed (a metal plate is connected to Pin 1 and Pin2) for UPS normal operation. To activate Emergency Power OFF (EPO) function, remove the two screws on the EPO port to remove the metal plate.

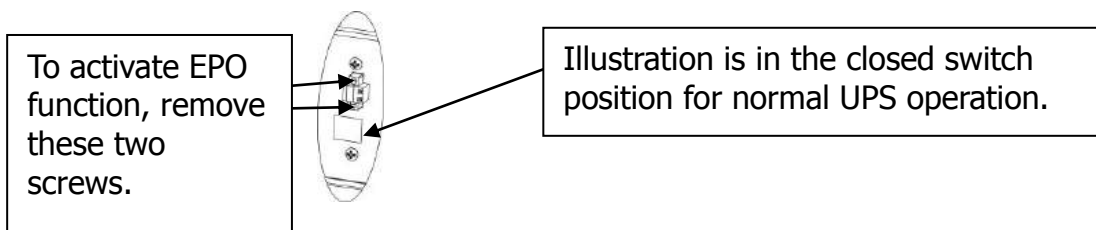

## **Step 5: Turn on the UPS**

Press the ON/Mute button on the front panel for two seconds to power on the UPS.

Note: The battery will fully charge during the first few hours of normal operation. Do not expect full battery run capability during this initial charge period.

## **Step 6: Software Installation**

For optimal computer system protection, install the UPS monitoring software to fully configure UPS shutdown.

Follow the steps below to download and install NetGuard monitoring software:

1. Go to the website [www.powershield.com.au](http://www.powershield.com.au)
2. Click Downloads software icon and choose your required OS to download the NetGuard software in the <https://powershield.com.au/downloads> downloads page.
3. Follow the on-screen instructions to install the NetGuard software.
4. When the computer re-starts, the NetGuard monitoring software will appear as an orange plug icon located in the system tray, near the clock.

## 3. Operations



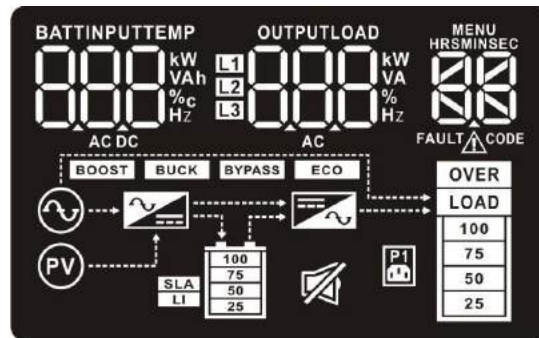

### 3-1. Button operation

Button	Function
ON/Mute Button	<ul style="list-style-type: none"><li>➤ Turn on the UPS: Press and hold ON/Mute button for at least 2 seconds to turn on the UPS.</li><li>➤ Mute the alarm: After the UPS is turned on in battery mode, press and hold this button for at least 3 seconds to disable or enable the alarm system. But it's not applied to the situations when warnings or errors occur.</li><li>➤ Up key: Press this button to display previous selection in UPS setting mode.</li><li>➤ Switch to UPS self-test mode: Press ON/Mute buttons for 3 seconds to enter UPS self-testing while in AC mode, ECO mode, or converter mode.</li></ul>
OFF/Enter Button	<ul style="list-style-type: none"><li>➤ Turn off the UPS: Press and hold this button at least 2 seconds to turn off the UPS. UPS will be in standby mode under power normal or transfer to Bypass mode if the Bypass enable setting by pressing this button.</li><li>➤ Confirm selection key: Press this button to confirm selection in UPS setting mode.</li></ul>
Select Button	<ul style="list-style-type: none"><li>➤ Switch LCD message: Press this button to change the LCD message for input voltage, input frequency, input current, battery voltage, battery current, battery capacity, ambient temperature, output voltage, output frequency, load current and load percent.</li><li>➤ Setting mode: Press and hold this button for 3 seconds to enter UPS setting mode when Standby and Bypass mode.</li><li>➤ Down key: Press this button to display next selection in UPS setting mode.</li></ul>
ON/Mute + Select Button	<ul style="list-style-type: none"><li>➤ Switch to bypass mode: When the main power is normal, press ON/Mute and Select buttons simultaneously for 3 seconds. Then UPS will enter to bypass mode. This action will be ineffective when the input voltage is out of acceptable range.</li><li>➤ Exit setting mode or return to the upper menu: When working in setting mode, press ON/Mute and Select buttons simultaneously for 0.2 seconds to return to the upper menu. If it's already in top menu, press these two buttons at the same time to exit the setting mode.</li></ul>

### 3-2. LCD Panel



Display	Function
<b>Backup time information</b>	
	Indicates the remaining backup time in numbers. HRS: hours, MIN: minutes, SEC: seconds
<b>Warning &amp; Fault information</b>	
	Indicates that a warning and fault occurs.
	Indicates the warning and fault codes as listed in detail in section 3-7 and 3-8.
<b>Setting Operation</b>	
	Indicates the setting operation, and the setting items are listed in details in section 3-5.
<b>Battery, Input, Temperature, Output and Load information</b>	
	Indicates the input voltage, input frequency, input ampere, battery voltage, battery ampere, battery capacity and ambient temperature. k: kilo, W: watt, V: voltage, A: ampere, %: percent, °C: centigrade degree, Hz: frequency, AC: alternating current, DC: direct current
	Indicate the output voltage, output frequency, output ampere, load current and load percentage. k: kilo, W: watt, V: voltage, A: ampere, %: percent, Hz: frequency, AC: alternating current
<b>Load information</b>	
	Indicates the load level by 0-24%, 25-49%, 50-74%, and 75-100%.
	Indicates overload.
<b>UPS status</b>	
	Indicates that programmable management outlets are working.
	Indicates the UPS alarm is disabled.
	Indicates the UPS is working in bypass mode.
	Indicates the UPS powers the output directly from the mains
	Indicates the UPS connects to the mains.

	Indicates the UPS connects to the PV
	Indicates the AC to DC circuit is working
	Indicates the inverter circuit is working
<b>Battery information</b>	
	Indicates the Battery level by 0-24%, 25-49%, 50-74%, and 75-100%.

### 3-3. Audible Alarm

Battery Mode	2 beeps every 30 seconds
Low Battery	Sounding every second
Overload	2 short beeps every 2 seconds
Fault	Continuously sounding
Bypass Mode	Sounding every 10 seconds

### 3-4. LCD display wordings index

Abbreviation	Display content	Meaning
ENA	ENR	Enable
DIS	dl S	Disable
ESC	ESC	Escape
HLS	HLS	High loss
LLS	LLS	Low loss
AO	AO	Active open
AC	AC	Active close
EAT	EAt	Estimated autonomy time
RAT	rAt	Running autonomy time
SD	Sd	Shutdown
OK	OK	OK
ON	ON	ON
BL	bL	Battery Low
OL	OL	Over Load
OI	OI	Over input current
NC	nC	Battery No Connect
OC	OC	Over Charge
SF	SF	Site wiring fault
EP	EP	EPO
TP	tP	Temperature
CH	CH	Charger

BF	bF	Battery Fault
BV	bV	Bypass Out Range
FU	FU	Bypass frequency unstable
BR	bR	Battery Replace
EE	EE	EEPROM error

### 3-5. UPS Parameter Settings

Parameter 2    Parameter 3    Parameter 1

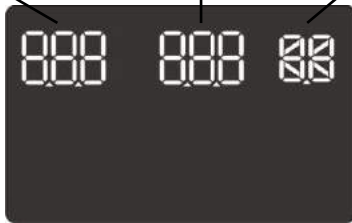

There are three parameters to set up the UPS.  
 Parameter 1: It's for program alternatives. Refer to below table.  
 Parameter 2&3: It's is the setting options or values for program.

#### ● 01: Output voltage setting

Interface	Setting
	<p><b>Parameter 2: Output voltage</b>            For 200/208/220/230/240 VAC models, you may choose the following output voltage:</p> <p><b>200:</b> presents output voltage is 200Vac  <b>208:</b> presents output voltage is 208Vac  <b>220:</b> presents output voltage is 220Vac  <b>230:</b> presents output voltage is 230Vac  <b>240:</b> presents output voltage is 240Vac (Default)</p>

#### ● 02: Frequency Converter enable/disable

Interface	Setting
	<p><b>Parameter 2:</b> Enable or disable converter mode. You may choose the following two options:</p> <p><b>CF ENA:</b> converter mode enable  <b>CF DIS:</b> converter mode disable (Default)</p>

#### ● 03: Output frequency setting

Interface	Setting
	<p><b>Parameter 2: Output frequency setting.</b>            You may set the initial frequency on battery mode:</p> <p><b>BAT 50:</b> presents output frequency is 50Hz  <b>BAT 60:</b> presents output frequency is 60Hz</p> <p>If converter mode is enabled, you may choose the following output frequency:</p> <p><b>CF 50:</b> presents output frequency is 50Hz  <b>CF 60:</b> presents output frequency is 60Hz</p>



● **04: ECO enable/disable**

Interface	Setting
	<p><b>Parameter 2:</b> Enable or disable ECO function. You may choose the following two options:  <b>ENA:</b> ECO mode enable  <b>DIS:</b> ECO mode disable (Default)</p>

● **05: ECO voltage range setting**

Interface	Setting
	<p><b>Parameter 2:</b> Set the acceptable high voltage point and low voltage point for ECO mode by pressing Down key or Up key.  <b>HLS:</b> High loss voltage in ECO mode in parameter 2. For 200/208/220/230/240 VAC models, the setting range in parameter 3 is from +7V to +24V of the nominal voltage. (Default: +12V)  <b>LLS:</b> Low loss voltage in ECO mode in parameter 2. For 200/208/220/230/240 VAC models, the setting range in parameter 3 is from -7V to -24V of the nominal voltage. (Default: -12V)</p>

● **06: Bypass enable/disable when UPS is off**

Interface	Setting
	<p><b>Parameter 2:</b> Enable or disable Bypass function. You may choose the following two options:  <b>ENA:</b> Bypass enable  <b>DIS:</b> Bypass disable (Default)</p>

● **07: Bypass voltage range setting**

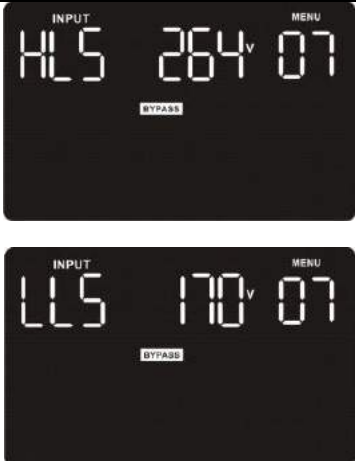
Interface	Setting
	<p><b>Parameter 2:</b> Set the acceptable high voltage point and acceptable low voltage point for Bypass mode by pressing the Down key or Up key.  <b>HLS:</b> Bypass high voltage point  For 200/208/220/230/240 VAC models:  <b>230-264:</b> setting the high voltage point in parameter 3 from 230Vac to 264Vac. (Default: 264Vac)  <b>LLS:</b> Bypass low voltage point  For 200/208/220/230/240 VAC models:  <b>170-220:</b> setting the low voltage point in parameter 3 from 170Vac to 220Vac. (Default: 170Vac)</p>

● **08: Bypass frequency range setting**

Interface	Setting
	<p><b>Parameter 2:</b> Set the acceptable high frequency point and acceptable low frequency point for Bypass mode by pressing the Down key or Up key.</p> <p><b>HLS:</b> Bypass high frequency point For 50Hz output frequency models: <b>51-55Hz:</b> setting the frequency high loss point from 51Hz to 55Hz(Default: 53.0Hz) For 60Hz output frequency models: <b>61-65Hz:</b> setting the frequency high loss point from 61Hz to 65Hz(Default: 63.0Hz)</p> <p><b>LLS:</b> Bypass low Frequency point For 50Hz output frequency models: <b>45-49Hz:</b> setting the frequency low loss point from 45Hz to 49Hz(Default: 47.0Hz) For 60Hz output frequency models: <b>55-59Hz:</b> setting the frequency low loss point from 55Hz to 59Hz(Default: 57.0Hz)</p>

● **09: Programmable outlets enable/disable**

Interface	Setting
	<p><b>Parameter 2:</b> Enable or disable programmable outlets.</p> <p><b>ENA:</b> Programmable outlets enable <b>DIS:</b> Programmable outlets disable (Default)</p>

● **10: Programmable outlets setting**

Interface	Setting
	<p><b>Parameter 2:</b> Set up backup time limits for programmable outlets.</p> <p><b>0-999:</b> setting the backup time limits in minutes from 0-999 for programmable outlets which connect to non-critical devices on battery mode. (Default: 999)</p>

● **11: Autonomy limitation setting**

Interface	Setting
	<p><b>Parameter 2:</b> Set up backup time on battery mode for general outlets.</p> <p><b>0-999:</b> setting the backup time in minutes from 0-999 for general outlets on battery mode.</p> <p><b>DIS:</b> Disable the autonomy limitation and the backup time will depend on battery capacity. (Default)</p> <p><b>Note:</b> When setting as "0", the backup time will be only 10 seconds.</p>

● **12: Charger boost voltage setting**

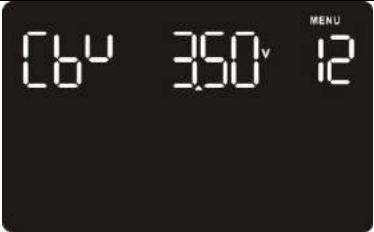
Interface	Setting
	<b>Parameter 2:</b> Set up the charger boost voltage. Default: 3.50V/cell. (not adjustable)

● **13: Charger float voltage setting**

Interface	Setting
	<b>Parameter 2:</b> Set up the charger float voltage. Default: 3.50V/cell. (not adjustable)

● **14: LCD display backlight setting**

Interface	Setting
	Aon: LCD display backlight is on all the time. (Default setting) Aut: LCD display backlight will turn off after 60 seconds if no buttons are pressed.

● **00: Exit setting**

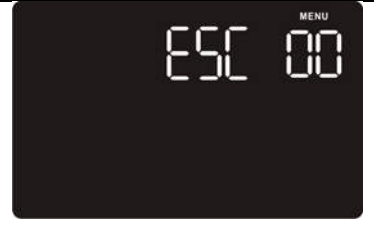
Interface	Setting
	Exit the setting mode.

**3-6. Operating Mode Description**

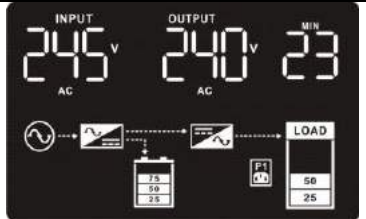
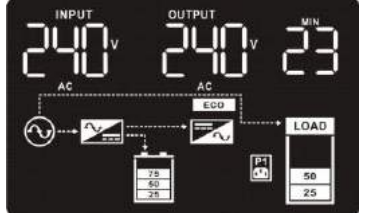
Operating mode	Description	LCD display
Online mode	When the input voltage is within acceptable range, UPS will provide pure and stable AC power to output. The UPS will also charge the battery at online mode.	
ECO mode	Energy saving mode: When the input voltage is within voltage regulation range, UPS will bypass voltage to output for energy saving. The UPS will also charge the battery at ECO mode.	

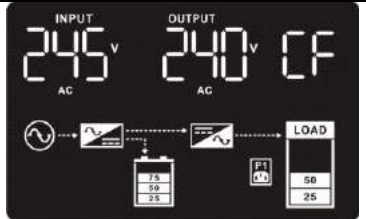
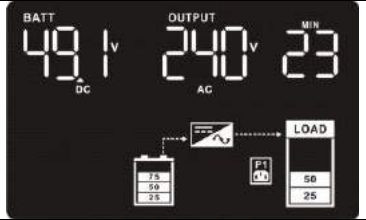
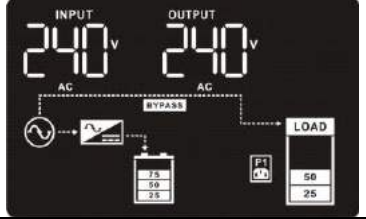
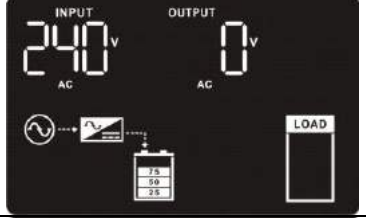
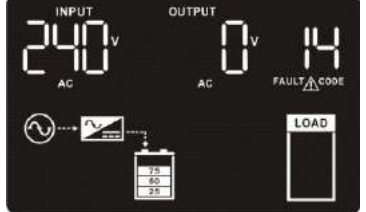
Frequency Converter mode	When input frequency is within 40 Hz to 70 Hz, the UPS can be set at a constant output frequency, 50 Hz or 60 Hz. The UPS will still charge battery under this mode.	
Battery mode	When the input voltage is beyond the acceptable range or power failure, the UPS will backup power from battery and alarm is sounding every 5 seconds.	
Bypass mode	When input voltage is within acceptable range but UPS is overload, UPS will enter bypass mode or bypass mode can be set by front panel. Alarm is sounding every 10 seconds.	
Standby mode	UPS is powered off and no output supply power, but still can charge batteries.	
Fault mode	When a fault has occurred, the ERROR icon and the fault code will be displayed.	

### 3-7. Faults Reference Code

Fault event	Fault code	Icon	Fault event	Fault code	Icon
Bus start fail	01	x	Battery voltage too high	27	X
Bus over	02	x	Battery voltage too low	28	X
Bus under	03	x	Charger output short	2A	X
Inverter soft start fail	11	x	Over temperature	41	X
Inverter voltage high	12	x	Overload	43	OVER LOAD
Inverter voltage Low	13	x	Charger failure	45	X













### 3-8. Warning indicator

Warning	Icon (flashing)	Code	Alarm
Low Battery		bL	Sounding every second
Overload		OL	2 short beeps every 2 seconds
Over input current		OI	Sounding 2 beep every 10 seconds
Battery is not connected		nc	2 short beeps every 2 seconds
Over Charge		OC	Continuously sounding
Site wiring fault		SF	2 short beeps every 2 seconds
EPO enable		EP	2 short beeps every 2 seconds
Over temperature		EP	Continuously sounding
Charger failure		CH	Continuously sounding
Battery fault		bF	Continuously sounding (At this time, UPS is off to remind users something wrong with battery)
Out of bypass voltage range		bV	2 short beeps every 2 seconds
Bypass frequency unstable		FU	2 short beeps every 2 seconds
Battery replacement		bR	2 short beeps every 2 seconds
EEPROM error		EE	2 short beeps every 2 seconds

**NOTE:** "Site Wiring Fault" function can be enabled/disabled via software. Please check software manual for the details.

## 4. Troubleshooting

If the UPS system does not operate correctly, please solve the problem by using the table below.

Symptom	Possible cause	Remedy
No indication and alarm even though the mains is normal.	The AC input power is not connected well.	Check if input power cord firmly connected to the mains.
	The AC input is connected to the UPS output.	Plug AC input power cord to AC input correctly.
The icon  and the warning code  flash on LCD display and alarm is sounding 2 short beeps every 2 seconds.	EPO function is activated.	Set the circuit in closed position to disable EPO function.
The icons of  and  and the warning code  flash on LCD display. Alarm is sounding 2 short beeps every 2 seconds.	Line and neutral conductors of UPS input are reversed.	Rotate mains power socket by 180° and then connect to UPS system.
The icons of  and  and the warning code  flash on LCD display. Alarm is sounding 2 short beeps every 2 seconds.	The external or internal battery is incorrectly connected.	Check if all batteries are connected well.
Fault code is shown as 27 on LCD display and alarm is continuously sounding.	Battery voltage is too high or the charger is fault.	Contact your dealer.
Fault code is shown as 28 on LCD display and alarm is continuously sounding.	Battery voltage is too low or the charger is fault.	Contact your dealer.
The icons  and  and the warning code  flash on LCD display. Alarm is sounding 2 short beeps every 2 seconds.	UPS is overload	Remove excess loads from UPS output.
	UPS is overloaded. Devices connected to the UPS are fed directly by the electrical network via the Bypass.	Remove excess loads from UPS output.
	After repetitive overloads, the UPS is locked in the Bypass mode. Connected devices are fed directly by the mains.	Remove excess loads from UPS output first. Then shut down the UPS and restart it.
Fault code is shown as 49 on LCD display and alarm is continuously sounding.	UPS is over input current.	Remove excess loads from UPS output.
Fault code is shown as 43 and the icon  is lighting on LCD display. Alarm is continuously sounding.	The UPS shut down automatically because of overload at the UPS output.	Remove excess loads from UPS output and restart it.

Symptom	Possible cause	Remedy
Fault code is shown as 14 on LCD display and alarm is continuously sounding.	The UPS shut down automatically because short circuit occurs on the UPS output.	Check output wiring and if connected devices are in short circuit status.
Fault code is shown as 01, 02, 03, 11, 12, 13 and 41 on LCD display and alarm is continuously sounding.	A UPS internal fault has occurred. There are two possible results: 1. The load is still supplied, but directly from AC power via bypass. 2. The load is no longer supplied by power.	Contact your dealer
Battery backup time is shorter than nominal value.	Batteries are not fully charged	Charge the batteries for at least 5 hours and then check capacity. If the problem still persists, consult your dealer.
	Batteries defect	Contact your dealer to replace the battery.
Fault code is shown as 2A on LCD display and alarm is continuously sounding.	The short circuit occurs on the charger output.	Check if battery wiring of connected external pack is in short circuit status.
Fault code is shown as 45 on LCD display. At the same time, alarm is continuously sounding.	The charger does not have output and battery voltage is less than 10V/PC.	Contact your dealer.

## 5. Storage and Maintenance

### 5-1. Operation

The UPS system contains no user-serviceable parts. Please contact your dealer if the battery service life (3~5 years at 25°C ambient temperature) has been exceeded, as the batteries must be replaced.



Be sure to deliver the spent LiFePO4 (LiFe) battery to a recycling facility or ship it to your dealer in the replacement battery packing material.

### 5-2. Storage

Before storing, charge the UPS for 5 hours. Store the UPS covered and upright in a cool, dry location. During storage, recharge the battery in accordance with the following table:

Storage Temperature	Recharge Frequency	Charging Duration
-10°C ~ 35°C	Every 3 months	1 hours @5~35°C
-10°C ~ 25°C	Every 6 months	1 hours@5~25°C



## 6. Specifications

### CENTURION RT LiFePO4 RANGE SELECTION GUIDE

MODEL	CENTURION RT LiFePO4 1kVA	CENTURION RT LiFePO4 2kVA	CENTURION RT LiFePO4 3kVA
Model Number	PSLCERT1000	PSLCERT2000	PSLCERT3000
Capacity	1000VA/900W	2000VA/1800W	3000VA/2700W
Topology	True online double- conversion, Pure Sine Wave		
<b>INPUT</b>			
Voltage Range	Low Line Transfer	160Vac / 140Vac / 120 / 110Vac $\pm$ 5 % (based on load percentage 100%-80% / 80%-70% / 70%-60% / 60%-0)	
	Low Line Comeback	175Vac / 155Vac / 135Vac / 125Vac $\pm$ 5 %	
	High Line Transfer	300Vac $\pm$ 5 %	
	High Line Comeback	290Vac $\pm$ 5 %	
Frequency Range	40Hz - 70Hz		
Phase	Single phase with ground		
Power Factor Correction	$\geq$ 0.99 @ nominal voltage (100% load)		
<b>OUTPUT</b>			
Output Power Factor	0.9		
Output Voltage (AC Mode)	240Vac (Selectable 200/208/220/230/240Vac)		
Voltage Regulation (Batt. Mode)	$\pm$ 1%		
Frequency Range (Batt. Mode)	50Hz or 60Hz $\pm$ 1Hz		
Current Crest Ratio	3:1 (max.)		
Transfer	AC Mode to Batt. Mode	Zero	
	Inverter to Bypass	4ms (Typical)	
Waveform (Batt. Mode)	Pure Sine Wave		
<b>EFFICIENCY</b>			
ECO Mode (Advanced)	96%	97%	97%
Battery Mode	87%	88%	89%
<b>BATTERY</b>			
Battery	LiFePO4		
Typical Recharge Time	2 hours		
Backup Time:			
50% Load	20 mins	20 mins	20 mins
100% Load	10 mins	10 mins	10 mins
<b>PROTECTION</b>			
Full Protection	Overload, discharge, thermal, short circuit and overcharge protection		
Surge Protection	1872 Joules / 39000 Amps		
<b>COMMUNICATIONS AND MANAGEMENT</b>			
Interface	USB or RS232 as standard, Intelligent slot for PSSNMP, PSModbus or PSAS400 dry contact		
Software	PowerShield® NetGuard® software - supports Windows, Linux, Unix and Mac based operating systems		
HID	Supports Windows, Apple, Linux, NAS and various industrial controllers		
LCD Display/Alarm	UPS Status, Load & Battery Level, Input/Output Voltage, Batt. Time Remaining and Fault Indicators		
Audible Alarm	Battery Mode, Bypass Mode, Low Battery (Batt. Mode), Fault, Overload		
<b>PHYSICAL</b>			
Dimension, (D x W x H) mm	380 x 438 x 88	480 x 438 x 88	600 x 438 x 88
Weight (kg)	10.2	14.4	19.3
<b>OPERATING ENVIRONMENT</b>			
Temperature	0 - 40°C		
Humidity	20 - 90% (RH Non-condensing)		
Noise Level	< 50dBA @ 1 Meter		
<b>COMPLIANCE</b>			
Safety / EMC / RoHS	EN62040-1-1 2003, IEC60950-1-1 / EN62040-2 2006 / Directive 2011/65/EU		

\* Specifications are subject to change without prior notice.



**Power Shield Pty Ltd Warranty Terms & Conditions** (PSW28012012)

**SERVICE / WARRANTY (Australia)**  
**(Tel) 1300-305-393**

**Warranty Conditions**

1. Power Shield product are warranted for certain specified period (see item 15 below) against failure due to faulty materials or workmanship from the invoice date from the Power Shield Store. Power Shields products are covered by a warranty in addition to all rights available to you by statute.
2. If, within the warranty period, the product does not meet the specification above and the product was installed and operated in accordance with Power Shield and Australian standards and procedures, then Power Shield will, correct any defects due to material or workmanship.
3. If the product has been modified, recalibrated, repaired, opened or tampered with in any way by the customer then its warranty will be void.
4. If the product has been damaged during transport then warranty will be void.
5. If product failed due to fire, earthquake, flood, direct lighting strike, terrorism, pollution, exposed under poison gas, and incorrect utility voltage then warranty will be void.
6. Batteries must be operated within the technical specification limits of the manufacturer and must be fully re-charged at least every three months during storage.
7. If Power Shield at its sole discretion determines that the product has failed, under Power Shield warranty conditions then Power Shield will at its option repair or replace the faulty unit
8. Power Shield will, at its sole discretion, replace the faulty product with an equal or equivalent model of a similar age and condition.
9. If the product, has failed due to reasons that Power Shield at its sole discretion, determines to be outside of warranty conditions, or is found to be not faulty then a minimum inspection and handling fee will be charged and also freight will be for the customer's account.
10. Blown fuses are usually as a result of overload and are not considered a warranty condition and a handling and inspection charge will apply as above
11. For hardwired products, larger than 3KVA, the warranty covers onsite repair for metro areas in capital cities only. For equipment installed in remote locations Power Shield may, at its sole discretion, request that the product be returned to a Power Shield service centre at the customer's cost,
12. Power Shield UPS products are not failsafe devices. Although well designed and manufactured, like all electrical, electronic and mechanical devices it has the potential to fail. This should be taken into consideration when designing any critical system
13. Subject to the applicable Law, in no event shall Power Shield Pty Ltd, it's officers, directors, affiliates or employees be liable for any form of indirect, special, consequential or punitive damages, arising out of the use, service or installation, of the products, whether such damages arise in contract or tort, irrespective of fault, negligence or strict liability or whether Power Shield Pty Ltd has been advised in advance of the possibility of such damages. Specifically, Power Shield Pty Ltd is not liable for any costs, such as lost profits or revenue, loss of equipment, loss of use of equipment, loss of software, loss of data, costs of substitution, claims by third parties, or otherwise.
14. Our products come with guarantees that cannot be excluded under the Australian Consumer Law. You are entitled to a replacement or refund for a major failure and compensation for any other reasonably foreseeable loss or damage. You are also entitled to have the products repaired or replaced if the products fail to be of acceptable quality and the failure does not amount to a major failure.
15. Warranty period commences from the date Power Shield invoices the goods  
ZapGuard Range: 1 year  
CompuGuard, SafeGuard, Defender, Commander, Centurion: 2 years  
Platinum Range: 1 year  
Gamatronic Range: 1 year

**To claim a warranty our contact details are as follows**

Call Service on 1300-305-393

Or

Visit <https://powershield.com.au/support-menu/rma-application/>  
to process an RMA

Or

Power Shield Pty Ltd (Head Office)  
U3, 205 Camboon Rd  
Malaga, WA 6090

Any claim for expenses must be provided to us in writing and should be sent to our office, detailed above.